



Module DLE G4 ADV

Modules DLE

Product description

- For downlights
- Luminous flux up to 6,350 lm at $t_p = 65\text{ °C}$
- High efficacy up to 185 lm/W for the LED module at $t_p = 25\text{ °C}$
- High system efficacy up to 158 lm/W at $t_p = 65\text{ °C}$
- High colour consistency (MacAdams 3)
- Safety glass for 5,000 lm version
- Fixing holes for M3 screws
- Built-in LED module
- Cooling required
- Flexible operating modes



With housing



Standards, page 5

Colour temperatures and tolerances, page 11

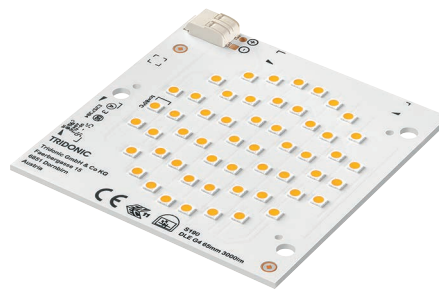

Without housing





Module DLE G4 ADV

Modules DLE

Technical data

Beam characteristic with housing	100°
Beam characteristic without housing	116°
Ambient temperature range	-20 ... +45 °C
tp rated	65 °C
tc	up to 85 °C
Irated for 2,000 lm	500 mA
Irated for 3,000 lm with housing	550 mA
Irated for 3,000 lm without housing	550 mA
Irated for 5,000 lm with housing	750 mA
I _{max} for 2,000 lm	935 mA
I _{max} for 3,000 lm with housing	700 mA
I _{max} for 3,000 lm without housing	1,290 mA
I _{max} for 5,000 lm with housing	1,290 mA
Max. permissible LF current ripple for 2,000 lm	1,030 mA
Max. permissible LF current ripple for 3,000 lm with housing	770 mA
Max. permissible LF current ripple for 3,000 lm without housing	1,420 mA
Max. permissible LF current ripple for 5,000 lm with housing	1,420 mA
Max. permissible peak current for 2,000 lm	2,400 mA / max. 5 ms
Max. permissible peak current for 3,000 lm with housing	2,700 mA / max. 5 ms
Max. permissible peak current for 3,000 lm without housing	2,700 mA / max. 5 ms
Max. permissible peak current for 5,000 lm with housing	2,700 mA / max. 5 ms
Max. working voltage for insulation ^①	60 V SELV
Insulation test voltage	0.5 kV
ESD classification	severity level 1
Risk group (EN 62471:2008)	RG1
Type of protection	IPO0

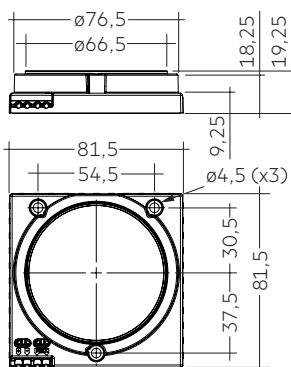

With housing (tc/tp position same as without housing) – Dimensions in mm

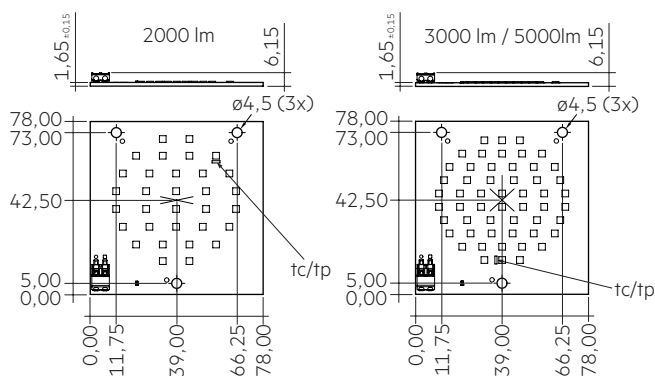

Without housing – Dimensions in mm

Ordering data

Type	Article number	Colour temperature	Casing	Packaging	Weight per pc.
DLE G4 65mm 2000lm 830 R ADV	89602870	3,000 K	no	24 pc(s).	0.029 kg
DLE G4 65mm 2000lm 840 R ADV	89602871	4,000 K	no	24 pc(s).	0.029 kg
DLE G4 65mm 3000lm 830 R ADV	89602872	3,000 K	no	24 pc(s).	0.029 kg
DLE G4 65mm 3000lm 840 R ADV	89602873	4,000 K	no	24 pc(s).	0.029 kg
DLE G4 65mm 2000lm 830 H ADV	89602874	3,000 K	yes	10 pc(s).	0.060 kg
DLE G4 65mm 2000lm 840 H ADV	89602875	4,000 K	yes	10 pc(s).	0.060 kg
DLE G4 65mm 3000lm 830 H ADV	89602876	3,000 K	yes	10 pc(s).	0.060 kg
DLE G4 65mm 3000lm 840 H ADV	89602877	4,000 K	yes	10 pc(s).	0.060 kg
DLE G4 65mm 5000lm 830 H ADV	89603014	3,000 K	yes	10 pc(s).	0.075 kg
DLE G4 65mm 5000lm 840 H ADV	89603015	4,000 K	yes	10 pc(s).	0.075 kg

Specific technical data

Type [®]	Photo-metric code	Forward current	Luminous flux at tp = 25 °C [®]	Luminous flux at tp = 65 °C [®]	Power consumption module [®]	Min. forward voltage module at tp = 65 °C	Max. forward voltage module at tp = 25 °C	Luminous efficacy module at tp = 25 °C [®]	Luminous efficacy module at tp = 65 °C [®]	Luminous efficacy system at tp = 65 °C [®] [®]	Colour rendering index CRI
DLE G4 65mm 2000lm – Module without housing – Operating mode HE											
DLE G4 65mm 2000lm 830 R ADV	830/359	400 mA	1,580 lm	1,470 lm	8,9 W	21,2 V	22,9 V	174 lm/W	164 lm/W	148 lm/W	80
DLE G4 65mm 2000lm 840 R ADV	840/359	350 mA	1,470 lm	1,360 lm	7,8 W	21,1 V	22,8 V	185 lm/W	175 lm/W	158 lm/W	80
DLE G4 65mm 2000lm – Module without housing – Operating mode NM											
DLE G4 65mm 2000lm 830 R ADV	830/359	500 mA	1,960 lm	1,820 lm	11,3 W	21,5 V	23,2 V	170 lm/W	161 lm/W	145 lm/W	80
DLE G4 65mm 2000lm 840 R ADV	840/359	500 mA	2,070 lm	1,920 lm	11,3 W	21,5 V	23,2 V	179 lm/W	169 lm/W	152 lm/W	80
DLE G4 65mm 2000lm – Module without housing – Operating mode HO											
DLE G4 65mm 2000lm 830 R ADV	830/359	700 mA	2,680 lm	2,480 lm	16,2 W	22,1 V	23,8 V	163 lm/W	154 lm/W	139 lm/W	80
DLE G4 65mm 2000lm 840 R ADV	840/359	650 mA	2,640 lm	2,440 lm	14,9 W	21,9 V	23,7 V	172 lm/W	163 lm/W	147 lm/W	80
DLE G4 65mm 3000lm – Module without housing – Operating mode HE											
DLE G4 65mm 3000lm 830 R ADV	830/359	450 mA	2,670 lm	2,480 lm	15,0 W	31,9 V	34,4 V	174 lm/W	165 lm/W	149 lm/W	80
DLE G4 65mm 3000lm 840 R ADV	840/359	450 mA	2,820 lm	2,620 lm	15,0 W	31,9 V	34,4 V	183 lm/W	173 lm/W	156 lm/W	80
DLE G4 65mm 3000lm – Module without housing – Operating mode NM											
DLE G4 65mm 3000lm 830 R ADV	830/359	550 mA	3,250 lm	3,010 lm	18,5 W	32,2 V	34,8 V	170 lm/W	161 lm/W	145 lm/W	80
DLE G4 65mm 3000lm 840 R ADV	840/359	550 mA	3,430 lm	3,180 lm	18,5 W	32,2 V	34,8 V	179 lm/W	170 lm/W	153 lm/W	80
DLE G4 65mm 3000lm – Module without housing – Operating mode HO											
DLE G4 65mm 3000lm 830 R ADV	830/359	650 mA	3,790 lm	3,510 lm	22,2 W	32,6 V	35,2 V	166 lm/W	157 lm/W	141 lm/W	80
DLE G4 65mm 3000lm 840 R ADV	840/359	650 mA	4,000 lm	3,710 lm	22,2 W	32,6 V	35,2 V	175 lm/W	166 lm/W	149 lm/W	80
DLE G4 65mm 3000lm – Module without housing – Operating mode HO2											
DLE G4 65mm 3000lm 830 R ADV	830/359	950 mA	5,320 lm	4,930 lm	33,3 W	33,7 V	36,2 V	156 lm/W	148 lm/W	133 lm/W	80
DLE G4 65mm 3000lm 840 R ADV	840/359	950 mA	5,610 lm	5,200 lm	33,3 W	33,7 V	36,2 V	165 lm/W	156 lm/W	140 lm/W	80
DLE G4 65mm 3000lm – Module without housing – Operating mode HO3											
DLE G4 65mm 3000lm 830 R ADV	830/359	1,200 mA	6,500 lm	6,020 lm	43,1 W	34,4 V	37,0 V	148 lm/W	140 lm/W	126 lm/W	80
DLE G4 65mm 3000lm 840 R ADV	840/359	1,200 mA	6,850 lm	6,350 lm	43,1 W	34,4 V	37,0 V	156 lm/W	148 lm/W	133 lm/W	80
DLE G4 65mm 2000lm – Module with housing – Operating mode HE											
DLE G4 65mm 2000lm 830 H ADV	830/359	400 mA	1,340 lm	1,240 lm	8,9 W	21,2 V	22,9 V	148 lm/W	139 lm/W	125 lm/W	80
DLE G4 65mm 2000lm 840 H ADV	840/359	350 mA	1,250 lm	1,150 lm	7,8 W	21,1 V	22,8 V	157 lm/W	148 lm/W	133 lm/W	80
DLE G4 65mm 2000lm – Module with housing – Operating mode NM											
DLE G4 65mm 2000lm 830 H ADV	830/359	500 mA	1,660 lm	1,540 lm	11,3 W	21,5 V	23,2 V	144 lm/W	137 lm/W	123 lm/W	80
DLE G4 65mm 2000lm 840 H ADV	840/359	500 mA	1,760 lm	1,630 lm	11,3 W	21,5 V	23,2 V	152 lm/W	143 lm/W	129 lm/W	80
DLE G4 65mm 2000lm – Module with housing – Operating mode HO											
DLE G4 65mm 2000lm 830 H ADV	830/359	700 mA	2,270 lm	2,100 lm	16,2 W	22,1 V	23,8 V	138 lm/W	130 lm/W	117 lm/W	80
DLE G4 65mm 2000lm 840 H ADV	840/359	650 mA	2,240 lm	2,070 lm	14,9 W	21,9 V	23,7 V	146 lm/W	138 lm/W	124 lm/W	80
DLE G4 65mm 3000lm – Module with housing – Operating mode HE											
DLE G4 65mm 3000lm 830 H ADV	830/359	450 mA	2,270 lm	2,100 lm	15,0 W	31,9 V	34,4 V	148 lm/W	139 lm/W	125 lm/W	80
DLE G4 65mm 3000lm 840 H ADV	840/359	450 mA	2,390 lm	2,220 lm	15,0 W	31,9 V	34,4 V	155 lm/W	147 lm/W	132 lm/W	80
DLE G4 65mm 3000lm – Module with housing – Operating mode NM											
DLE G4 65mm 3000lm 830 H ADV	830/359	550 mA	2,760 lm	2,550 lm	18,5 W	32,2 V	34,8 V	144 lm/W	136 lm/W	122 lm/W	80
DLE G4 65mm 3000lm 840 H ADV	840/359	550 mA	2,910 lm	2,690 lm	18,5 W	32,2 V	34,8 V	152 lm/W	144 lm/W	130 lm/W	80
DLE G4 65mm 3000lm – Module with housing – Operating mode HO											
DLE G4 65mm 3000lm 830 H ADV	830/359	650 mA	3,220 lm	2,980 lm	22,2 W	32,6 V	35,2 V	141 lm/W	133 lm/W	120 lm/W	80
DLE G4 65mm 3000lm 840 H ADV	840/359	650 mA	3,390 lm	3,150 lm	22,2 W	32,6 V	35,2 V	148 lm/W	141 lm/W	127 lm/W	80
DLE G4 65mm 5000lm – Module with housing – Operating mode HE											
DLE G4 65mm 5000lm 830 H ADV	830/359	550 mA	2,760 lm	2,550 lm	18,5 W	32,2 V	34,8 V	144 lm/W	136 lm/W	122 lm/W	80
DLE G4 65mm 5000lm 840 H ADV	840/359	550 mA	2,910 lm	2,690 lm	18,5 W	32,2 V	34,8 V	152 lm/W	144 lm/W	130 lm/W	80
DLE G4 65mm 5000lm – Module with housing – Operating mode NM											
DLE G4 65mm 5000lm 830 H ADV	830/359	750 mA	3,630 lm	3,370 lm	25,8 W	33,0 V	35,5 V	138 lm/W	130 lm/W	117 lm/W	80
DLE G4 65mm 5000lm 840 H ADV	840/359	750 mA	3,830 lm	3,550 lm	25,8 W	33,0 V	35,5 V	145 lm/W	137 lm/W	123 lm/W	80
DLE G4 65mm 5000lm – Module with housing – Operating mode HO											
DLE G4 65mm 5000lm 830 H ADV	830/359	1,200 mA	5,460 lm	5,050 lm	43,1 W	34,4 V	37,0 V	124 lm/W	118 lm/W	106 lm/W	80
DLE G4 65mm 5000lm 840 H ADV	840/359	1,200 mA	5,750 lm	5,330 lm	43,1 W	34,4 V	37,0 V	131 lm/W	124 lm/W	112 lm/W	80

[®] Measured at operating mode HO.

[®] Tolerance range for optical and electrical data: ±10 %.

[®] HE ... high efficiency, NM ... nominal mode, HO ... high output.

[®] Assumed efficiency for the LED engine is 0,9.

Product description

- The adapter plate does not replace a heat sink

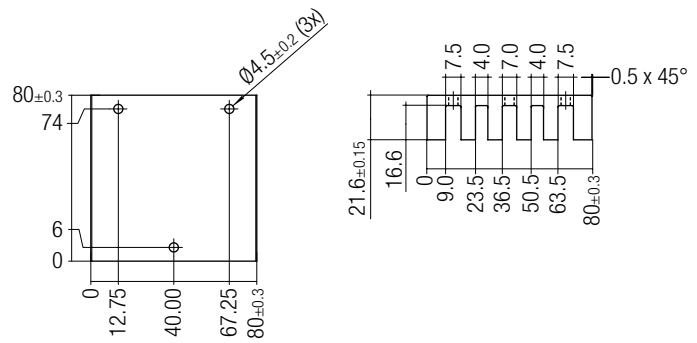
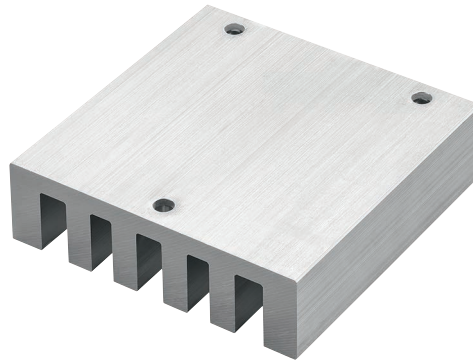

Ordering data

Type	Article number	Packaging	Weight per pc.
DLE GEN2 Adapter	28000420	1 pc(s).	0.250 kg

1. Standards

IEC 62031
IEC 62471
IEC 62778
IEC 61547

1.1 Glow wire test

according to EN 62031 with increased temperature of 650 °C passed.

1.2 Photometric code

Key for photometric code, e. g. 830 / 359

1 st digit	2 nd + 3 rd digit	4 th digit	5 th digit	6 th digit	
Code	CRI	Colour temperature in Kelvin x 100	McAdam initial	McAdam after 25% of the life-time (max.6000h)	Luminous flux after 25% of the life-time (max.6000h)
7	70 – 79			Code	Luminous flux
8	80 – 89			7	≥ 70 %
9	≥90			8	≥ 80 %
				9	≥ 90 %

1.3 Energy classification

Typ	Forward current	Energy classification
DLE G4 65mm 2000lm 830 R ADV	400 mA	A++
	500 mA	A++
	700 mA	A++
DLE G4 65mm 2000lm 840 R ADV	350 mA	A++
	500 mA	A++
	650 mA	A++
DLE G4 65mm 3000lm 830 R ADV	450 mA	A++
	550 mA	A++
	650 mA	A++
DLE G4 65mm 3000lm 840 R ADV	950 mA	A++
	1,200 mA	A++
	450 mA	A++
DLE G4 65mm 2000lm 830 H ADV	550 mA	A++
	700 mA	A++
	350 mA	A++
DLE G4 65mm 2000lm 840 H ADV	500 mA	A++
	650 mA	A++
	450 mA	A++
DLE G4 65mm 3000lm 830 H ADV	550 mA	A++
	650 mA	A+
	450 mA	A++
DLE G4 65mm 3000lm 840 H ADV	550 mA	A++
	650 mA	A++
	550 mA	A++
DLE G4 65mm 5000lm 830 H ADV	750 mA	A+
	1,200 mA	A+
	550 mA	A++
DLE G4 65mm 5000lm 840 H ADV	750 mA	A++
	1,200 mA	A+

2. Thermal details

2.1 tp point, ambient temperature and life-time

The temperature at tp reference point is crucial for the light output and life-time of a LED product.

For DLE G4 a tp temperature of 65 °C has to be complied in order to achieve an optimum between heat sink requirements, light output and life-time.

Compliance with the maximum permissible reference temperature at the tp point must be checked under operating conditions in a thermally stable state. The maximum value must be determined under worst-case conditions for the relevant application.

To check the tc / tp temperature, the temperature sensor has to be mounted on the PCB at the marked position as stated in the drawing.

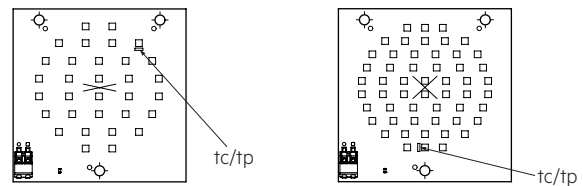

2.2 Storage and humidity

storage temperature	-30 ... +80 °C
---------------------	----------------

Operation only in non condensing environment.

Humidity during processing of the module should be between 30 to 70 %.

2.3 Derating curves

DLE G4 65mm 2000lm 8x0 R ADV

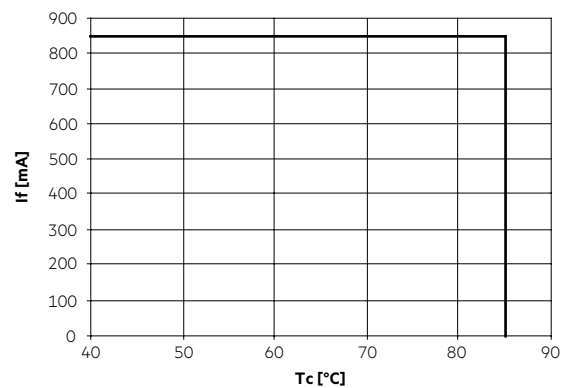

DLE G4 65mm 3000lm 8x0 R ADV

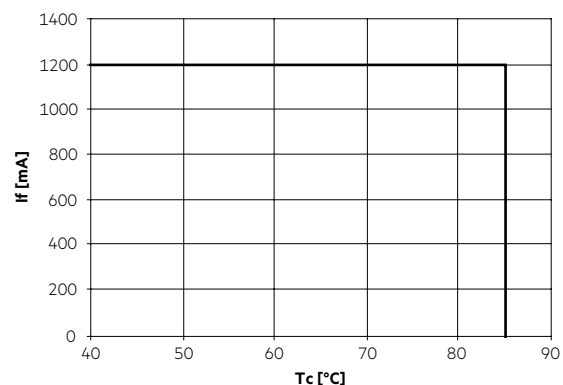

DLE G4 65mm 2000lm 830 H ADV (with housing)

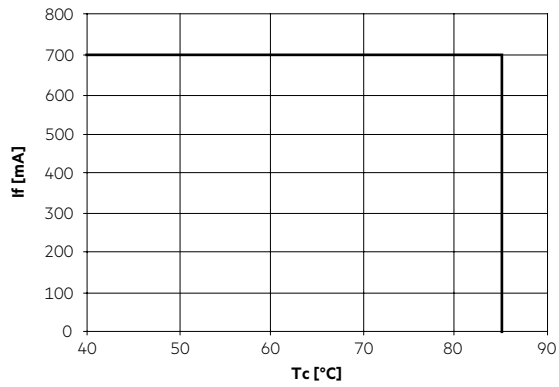

DLE G4 65mm 2000lm 840 H ADV (with housing)

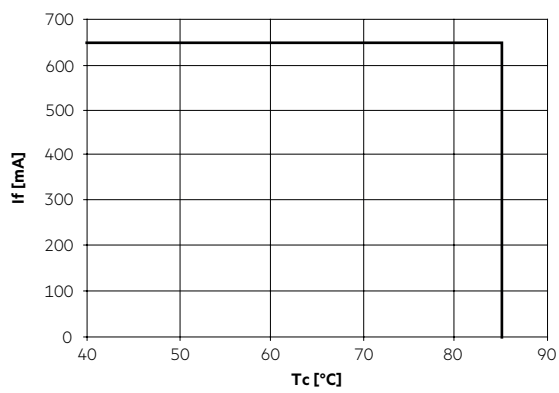

DLE G4 65mm 3000lm 8x0 H ADV (with housing)

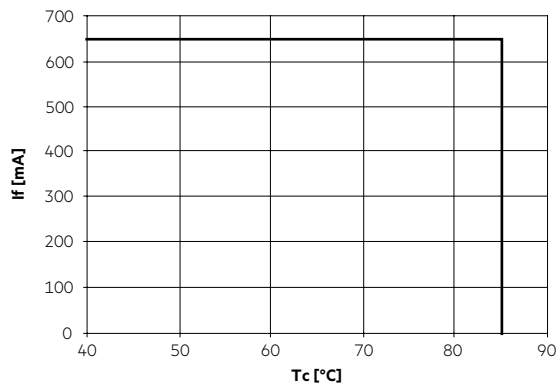

DLE G4 65mm 5000lm 8x0 H ADV (with housing)

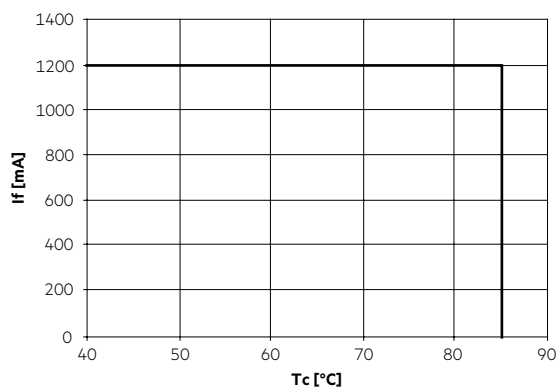

2.4 Thermal design and heat sink

The rated life of LED products depends to a large extent on the temperature. If the permissible temperature limits are exceeded, the life of the DLE G4 will be greatly reduced or the DLE G4 may be destroyed.

2.5 Heat sink values

DLE G4 65mm 2000lm 830 ADVANCED

ta	tp	Forward current	R _{th, hs-a}
25°C	65°C	400 mA	8.00 K/W
35°C	65°C	400 mA	6.00 K/W
45°C	65°C	400 mA	4.00 K/W
55°C	65°C	400 mA	2.00 K/W
25°C	65°C	500 mA	6.54 K/W
35°C	65°C	500 mA	4.90 K/W
45°C	65°C	500 mA	3.27 K/W
55°C	65°C	500 mA	1.63 K/W
25°C	65°C	700 mA	4.32 K/W
35°C	65°C	700 mA	3.24 K/W
45°C	65°C	700 mA	2.16 K/W
55°C	65°C	700 mA	1.08 K/W

DLE G4 65mm 2000lm 840 ADVANCED

ta	tp	Forward current	R _{th, hs-a}
25°C	65°C	350 mA	10.46 K/W
35°C	65°C	350 mA	7.84 K/W
45°C	65°C	350 mA	5.23 K/W
55°C	65°C	350 mA	2.61 K/W
25°C	65°C	500 mA	6.79 K/W
35°C	65°C	500 mA	5.09 K/W
45°C	65°C	500 mA	3.39 K/W
55°C	65°C	500 mA	1.69 K/W
25°C	65°C	650 mA	4.68 K/W
35°C	65°C	650 mA	3.51 K/W
45°C	65°C	650 mA	2.34 K/W
55°C	65°C	650 mA	1.17 K/W

DLE G4 65mm 3000lm 830 ADVANCED

ta	tp	Forward current	R _{th, hs-a}
25°C	65°C	450 mA	5.06 K/W
35°C	65°C	450 mA	3.79 K/W
45°C	65°C	450 mA	2.53 K/W
55°C	65°C	450 mA	1.26 K/W
25°C	65°C	550 mA	3.92 K/W
35°C	65°C	550 mA	2.94 K/W
45°C	65°C	550 mA	1.96 K/W
55°C	65°C	550 mA	0.98 K/W
25°C	65°C	650 mA	3.25 K/W
35°C	65°C	650 mA	2.43 K/W
45°C	65°C	650 mA	1.62 K/W
55°C	65°C	650 mA	0.81 K/W
25°C	65°C	1,200 mA	1.52 K/W
35°C	65°C	1,200 mA	1.15 K/W
45°C	65°C	1,200 mA	0.77 K/W
55°C	65°C	1,200 mA	0.38 K/W

DLE G4 65mm 3000lm 840 ADVANCED

ta	tp	Forward current	R _{th, hs-a}
25°C	65°C	450 mA	5.24 K/W
35°C	65°C	450 mA	3.93 K/W
45°C	65°C	450 mA	2.62 K/W
55°C	65°C	450 mA	1.31 K/W
25°C	65°C	550 mA	4.18 K/W
35°C	65°C	550 mA	3.13 K/W
45°C	65°C	550 mA	2.09 K/W
55°C	65°C	550 mA	1.04 K/W
25°C	65°C	650 mA	3.36 K/W
35°C	65°C	650 mA	2.52 K/W
45°C	65°C	650 mA	1.68 K/W
55°C	65°C	650 mA	0.84 K/W
25°C	65°C	1,200 mA	1.61 K/W
35°C	65°C	1,200 mA	1.19 K/W
45°C	65°C	1,200 mA	0.78 K/W
55°C	65°C	1,200 mA	0.41 K/W

DLE G4 65mm 5000lm 830 ADVANCED

ta	tp	Forward current	R _{th, hs-a}
25°C	65°C	550 mA	3.92 K/W
35°C	65°C	550 mA	2.94 K/W
45°C	65°C	550 mA	1.96 K/W
55°C	65°C	550 mA	0.98 K/W
25°C	65°C	750 mA	2.69 K/W
35°C	65°C	750 mA	2.50 K/W
45°C	65°C	750 mA	1.35 K/W
55°C	65°C	750 mA	0.67 K/W
25°C	65°C	950 mA	2.05 K/W
35°C	65°C	950 mA	1.54 K/W
45°C	65°C	950 mA	1.00 K/W
55°C	65°C	950 mA	0.50 K/W
25°C	65°C	1,200 mA	1.52 K/W
35°C	65°C	1,200 mA	1.15 K/W
45°C	65°C	1,200 mA	0.77 K/W
55°C	65°C	1,200 mA	0.38 K/W

DLE G4 65mm 5000lm 840 ADVANCED

ta	tp	Forward current	R _{th, hs-a}
25°C	65°C	550 mA	4.18 K/W
35°C	65°C	550 mA	3.13 K/W
45°C	65°C	550 mA	2.09 K/W
55°C	65°C	550 mA	1.04 K/W
25°C	65°C	750 mA	2.82 K/W
35°C	65°C	750 mA	2.10 K/W
45°C	65°C	750 mA	1.41 K/W
55°C	65°C	750 mA	0.71 K/W
25°C	65°C	950 mA	2.13 K/W
35°C	65°C	950 mA	1.59 K/W
45°C	65°C	950 mA	1.06 K/W
55°C	65°C	950 mA	0.53 K/W
25°C	65°C	1,200 mA	1.61 K/W
35°C	65°C	1,200 mA	1.19 K/W
45°C	65°C	1,200 mA	0.78 K/W
55°C	65°C	1,200 mA	0.41 K/W

Notes

The actual cooling can differ because of the material, the structural shape, outside influences and the installation situation. A thermal connection between DLE G4 and heat sink with heat-conducting paste or heat conducting adhesive film is absolutely necessary.

Additionally the DLE G4 has to be fixed on the heat sink with M3 screws to optimise the thermal connection.

Use of thermal interface material with thermal conductivity of $\lambda > 1 \text{ W/mK}$ and layer thickness of interface material with max. 50 μm or a similar interface material where the quotient of layer thickness and thermal conductivity $b < 50 \mu\text{mmK/W}$.

3. Installation / wiring

3.1 Electrical supply/choice of LED Driver

DLE G4 from Tridonic are not protected against overvoltages, overcurrents, overloads or short-circuit currents. Safe and reliable operation can only be guaranteed in conjunction with a LED Driver which complies with the relevant standards. The use of LED Drivers from Tridonic in combination with DLE G4 guarantees the necessary protection for safe and reliable operation.

If a LED Driver other than Tridonic is used, it must provide the following protection:

- Short-circuit protection
- Overload protection
- Overtemperature protection

! DLE G4 must be supplied by a constant current LED Driver. Operation with a constant voltage LED Driver will lead to an irreversible damage of the module. Wrong polarity can damage the DLE G4.

! DLE G4 are basic isolated up to 60 V SELV against ground and can be mounted directly on earthed metal parts of the luminaire. If the max. output voltage of the LED Driver (also against earth) is above 60 V SELV, an additional isolation between LED module and heat sink is required (for example by isolated thermal pads) or by a suitable luminaire construction. At voltages > 60 V an additional protection against direct touch (test finger) to the light emitting side of the module has to be guaranteed. This is typically achieved by means of a non removable light distributor over the module.

3.3 Wiring

Wiring with housing

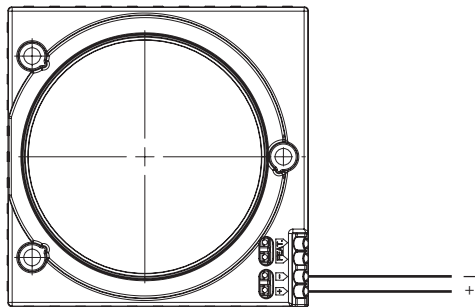

Wiring without housing

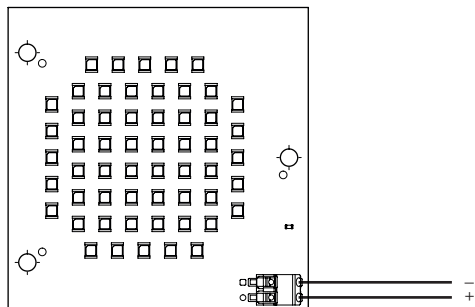

Wiring example

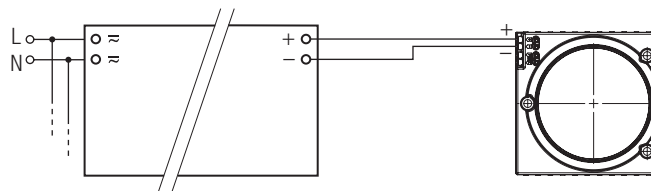

TALEXdriver LC...

3.4 Wiring type and cross section

The wiring can be solid or stranded wires with a cross section of 0.2 to 0.75 mm².

For the push-wire connection you have to strip the insulation (7–9 mm). Loosen wire through twisting and pulling.

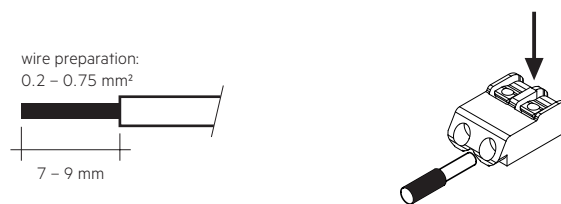

Release of the wiring

Press down the "push button" and remove the cable from front.

3.4 Mounting instruction

! DLE G4 from Tridonic which have to be installed on a heat sink have to be connected with heat-conducting paste or heat conducting adhesive film and fixed with M3 screws.

The fixing/cooling surface must be cleaned by removing all dirt, dust and grease before installing the LED modules.

None of the components of the DLE G4 (substrate, LED, electronic components etc.) may be exposed to tensile or compressive stresses.

! Max. torque for fixing: 0.5 Nm.

The LED modules are mounted with 3 screws per module. In order not to damage the modules only rounded head screws and an additional plastic flat washer should be used for LED modules without housing.

For further information please refer to the brochure entitled "Technical Design-In-Guide DLE GEN3".

! Chemical substance may harm the LED module. Chemical reactions could lead to colour shift, reduced luminous flux or a total failure of the module caused by corrosion of electrical connections.

Materials which are used in LED applications (e.g. sealings, adhesives) must not produce dissolver gas. They must not be condensation curing based, acetate curing based or contain sulfur, chlorine or phthalate.

Avoid corrosive atmosphere during usage and storage.

3.6 EOS/ESD safety guidelines

! The device / module contains components that are sensitive to electrostatic discharge and may only be installed in the factory and on site if appropriate EOS/ESD protection measures have been taken. No special measures need be taken for devices/modules with enclosed casings (contact with the pc board not possible), just normal installation practice.

For further information for EOS/ESD safety guidelines and the ESD classification please refer to the brochure entitled <http://www.tridonic.com/esd-protection>.

4. Life-time

4.1 Life-time, lumen maintenance and failure rate

The light output of an LED Module decreases over the life-time, this is characterized with the L value. L70 means that the LED module will give 70 % of its initial luminous flux. This value is always related to the number of operation hours and therefore defines the life-time of an LED module.

As the L value is a statistical value and the lumen maintenance may vary over the delivered LED modules. The B value defines the amount of modules which are below the specific L value, e.g. L70B10 means 10 % of the LED modules are below 70 % of the initial luminous flux, respectively 90 % will be above 70 % of the initial value.

In addition the percentage of failed modules (fatal failure) is characterized by the C value.

The F value is the combination of the B and C value. That means for F degradation and complete failures are considered, e.g. L70F10 means 10 % of the LED modules may fail or be below 70 % of the initial luminous flux.

4.2 Lumen maintenance

DLE G4 65mm 2000lm 8x0 ADVANCED

Operating current	tp temperature	L90 / F10	L90 / F50	L80 / F10	L80 / F50	L70 / F10	L70 / F50
350 mA	55 °C	>50,000 h	>50,000 h	>50,000 h	>50,000 h	>50,000 h	>50,000 h
	65 °C	>50,000 h	>50,000 h	>50,000 h	>50,000 h	>50,000 h	>50,000 h
	75 °C	>50,000 h	>50,000 h	>50,000 h	>50,000 h	>50,000 h	>50,000 h
	85 °C	>50,000 h	>50,000 h	>50,000 h	>50,000 h	>50,000 h	>50,000 h
450 mA	55 °C	>50,000 h	>50,000 h	>50,000 h	>50,000 h	>50,000 h	>50,000 h
	65 °C	>50,000 h	>50,000 h	>50,000 h	>50,000 h	>50,000 h	>50,000 h
	75 °C	>50,000 h	>50,000 h	>50,000 h	>50,000 h	>50,000 h	>50,000 h
	85 °C	>50,000 h	>50,000 h	>50,000 h	>50,000 h	>50,000 h	>50,000 h
500 mA	55 °C	40,000 h	50,000 h	>50,000 h	>50,000 h	>50,000 h	>50,000 h
	65 °C	40,000 h	50,000 h	>50,000 h	>50,000 h	>50,000 h	>50,000 h
	75 °C	40,000 h	50,000 h	>50,000 h	>50,000 h	>50,000 h	>50,000 h
	85 °C	40,000 h	50,000 h	>50,000 h	>50,000 h	>50,000 h	>50,000 h
650 mA	55 °C	40,000 h	50,000 h	>50,000 h	>50,000 h	>50,000 h	>50,000 h
	65 °C	40,000 h	50,000 h	>50,000 h	>50,000 h	>50,000 h	>50,000 h
	75 °C	40,000 h	50,000 h	>50,000 h	>50,000 h	>50,000 h	>50,000 h
	85 °C	40,000 h	50,000 h	>50,000 h	>50,000 h	>50,000 h	>50,000 h
700 mA	55 °C	40,000 h	50,000 h	>50,000 h	>50,000 h	>50,000 h	>50,000 h
	65 °C	40,000 h	50,000 h	>50,000 h	>50,000 h	>50,000 h	>50,000 h
	75 °C	40,000 h	50,000 h	>50,000 h	>50,000 h	>50,000 h	>50,000 h
	85 °C	40,000 h	50,000 h	>50,000 h	>50,000 h	>50,000 h	>50,000 h

DLE G4 65mm 3000lm 8x0 ADVANCED

Operating current	tp temperature	L90 / F10	L90 / F50	L80 / F10	L80 / F50	L70 / F10	L70 / F50
450 mA	55 °C	>50,000 h	>50,000 h	>50,000 h	>50,000 h	>50,000 h	>50,000 h
	65 °C	>50,000 h	>50,000 h	>50,000 h	>50,000 h	>50,000 h	>50,000 h
	75 °C	>50,000 h	>50,000 h	>50,000 h	>50,000 h	>50,000 h	>50,000 h
	85 °C	>50,000 h	>50,000 h	>50,000 h	>50,000 h	>50,000 h	>50,000 h
550 mA	55 °C	40,000 h	50,000 h	>50,000 h	>50,000 h	>50,000 h	>50,000 h
	65 °C	40,000 h	50,000 h	>50,000 h	>50,000 h	>50,000 h	>50,000 h
	75 °C	40,000 h	50,000 h	>50,000 h	>50,000 h	>50,000 h	>50,000 h
	85 °C	40,000 h	50,000 h	>50,000 h	>50,000 h	>50,000 h	>50,000 h
650 mA	55 °C	40,000 h	50,000 h	>50,000 h	>50,000 h	>50,000 h	>50,000 h
	65 °C	40,000 h	50,000 h	>50,000 h	>50,000 h	>50,000 h	>50,000 h
	75 °C	40,000 h	50,000 h	>50,000 h	>50,000 h	>50,000 h	>50,000 h
	85 °C	40,000 h	50,000 h	>50,000 h	>50,000 h	>50,000 h	>50,000 h
950 mA	55 °C	33,000 h	40,000 h	>50,000 h	>50,000 h	>50,000 h	>50,000 h
	65 °C	33,000 h	40,000 h	>50,000 h	>50,000 h	>50,000 h	>50,000 h
	75 °C	33,000 h	40,000 h	>50,000 h	>50,000 h	>50,000 h	>50,000 h
	85 °C	33,000 h	40,000 h	>50,000 h	>50,000 h	>50,000 h	>50,000 h
1,200 mA	55 °C	26,000 h	33,000 h	>50,000 h	>50,000 h	>50,000 h	>50,000 h
	65 °C	26,000 h	33,000 h	>50,000 h	>50,000 h	>50,000 h	>50,000 h
	75 °C	26,000 h	33,000 h	>50,000 h	>50,000 h	>50,000 h	>50,000 h
	85 °C	26,000 h	33,000 h	>50,000 h	>50,000 h	>50,000 h	>50,000 h

DLE G4 65mm 5000lm 8x0 ADVANCED

Operating current	tp temperature	L90 / F10	L90 / F50	L80 / F10	L80 / F50	L70 / F10	L70 / F50
550 mA	55 °C	40,000 h	50,000 h	>50,000 h	>50,000 h	>50,000 h	>50,000 h
	65 °C	40,000 h	50,000 h	>50,000 h	>50,000 h	>50,000 h	>50,000 h
	75 °C	40,000 h	50,000 h	>50,000 h	>50,000 h	>50,000 h	>50,000 h
	85 °C	40,000 h	50,000 h	>50,000 h	>50,000 h	>50,000 h	>50,000 h
750 mA	55 °C	50,000 h	40,000 h	>50,000 h	>50,000 h	>50,000 h	>50,000 h
	65 °C	50,000 h	40,000 h	>50,000 h	>50,000 h	>50,000 h	>50,000 h
	75 °C	50,000 h	40,000 h	>50,000 h	>50,000 h	>50,000 h	>50,000 h
	85 °C	50,000 h	40,000 h	>50,000 h	>50,000 h	>50,000 h	>50,000 h
950 mA	55 °C	33,000 h	40,000 h	>50,000 h	>50,000 h	>50,000 h	>50,000 h
	65 °C	33,000 h	40,000 h	>50,000 h	>50,000 h	>50,000 h	>50,000 h
	75 °C	33,000 h	40,000 h	>50,000 h	>50,000 h	>50,000 h	>50,000 h
	85 °C	33,000 h	40,000 h	>50,000 h	>50,000 h	>50,000 h	>50,000 h
1,200 mA	55 °C	26,000 h	33,000 h	>50,000 h	>50,000 h	>50,000 h	>50,000 h
	65 °C	26,000 h	33,000 h	>50,000 h	>50,000 h	>50,000 h	>50,000 h
	75 °C	26,000 h	33,000 h	>50,000 h	>50,000 h	>50,000 h	>50,000 h
	85 °C	26,000 h	33,000 h	>50,000 h	>50,000 h	>50,000 h	>50,000 h

5. Electrical values

5.1 Typ. forward voltage vs. forward current at tp = 65 °C

DLE G4 65mm 2000lm 8x0 ADVANCED

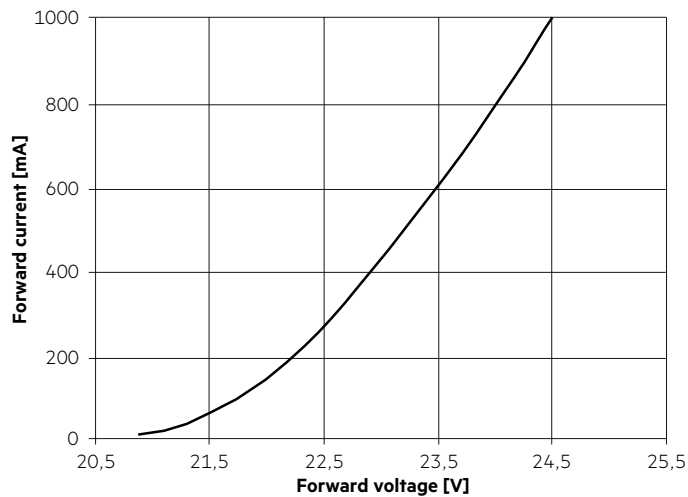

DLE G4 65mm 3000lm / 5000lm 8x0 ADVANCED

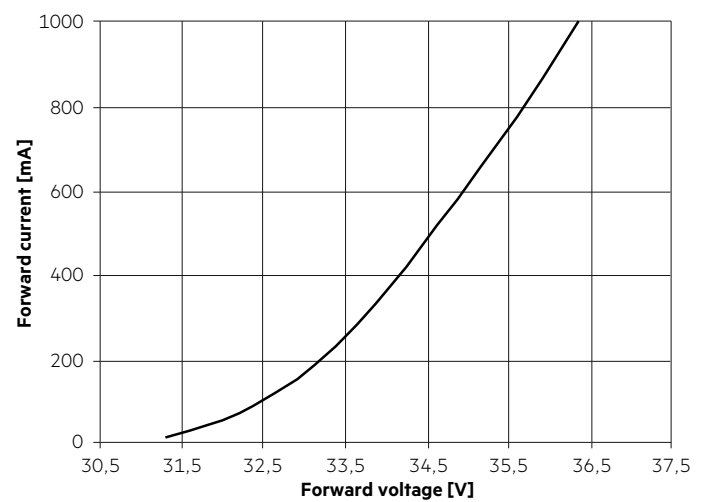

5.2 Forward voltage vs. tp temperature

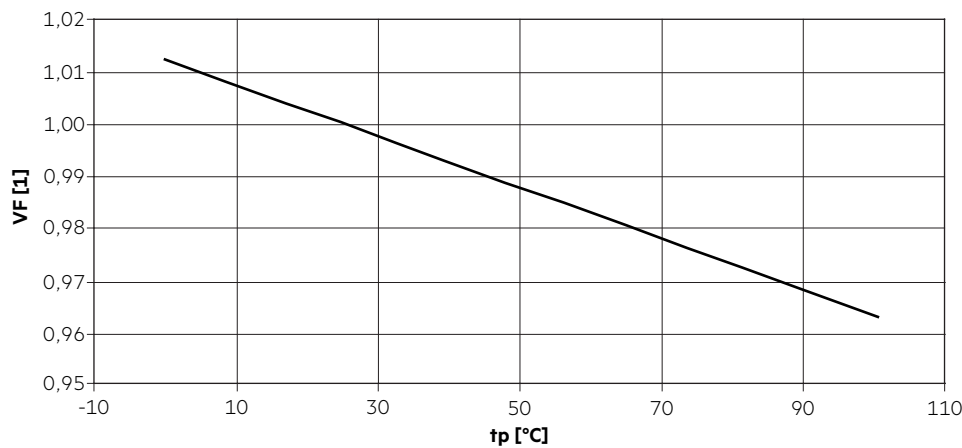

The diagrams based on statistic values.
The real values can be different.

6. Photometric characteristics

6.1 Coordinates and tolerances according to CIE 1931

The specified colour coordinates are measured integral after a settling time of 100 ms. The current impuls depends on the module type.

Module type	Current impulse
DLE G4 65mm 2000lm 8x0 ADV	500 mA
DLE G4 65mm 3000lm 8x0 ADV	550 mA
DLE G4 65mm 5000lm 8x0 ADV	550 mA

The ambient temperature of the measurement is $t_a = 25^\circ\text{C}$.
The measurement tolerance of the colour coordinates are ± 0.01 .

6.2 Colour coordinates for LED module without housing

3,000 K

	x0	y0
Centre	0.4362	0.4025

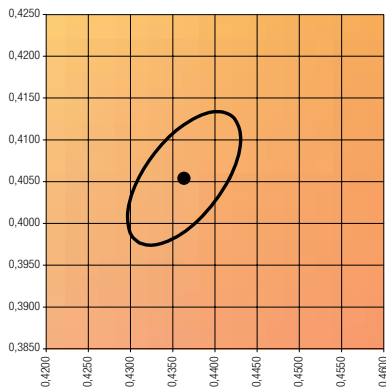

MacAdam ellipse: 3SDCM

	x	y
Colour shift DLE G4 R to DLE G4 H for 2,000 lm	+0.0015	+0.0005
Colour shift DLE G4 R to DLE G4 H for 3,000 lm	+0.0030	+0.0010
Colour shift DLE G4 R 3,000 lm to DLE G4 H for 5,000 lm	+0.0004	+0.0006

4,000 K

	x0	y0
Centre	0.3825	0.3796

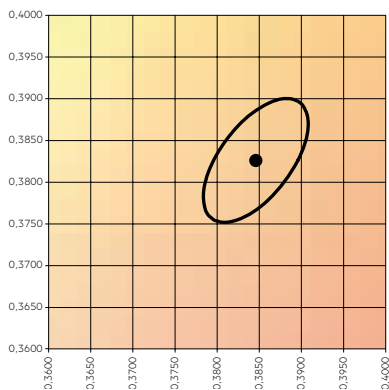

MacAdam ellipse: 3SDCM

	x	y
Colour shift DLE G4 R to DLE G4 H for 2,000 lm	+0.0016	+0.0017
Colour shift DLE G4 R to DLE G4 H for 3,000 lm	+0.0033	+0.0028
Colour shift DLE G4 R 3,000 lm to DLE G4 H for 5,000 lm	+0.0004	+0.0018

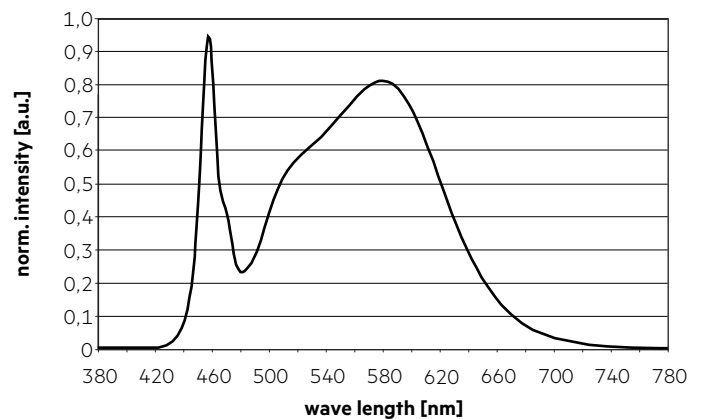
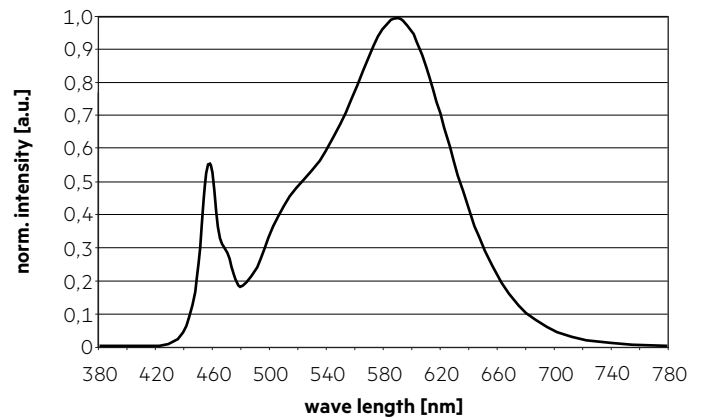

6.3 Light distribution

The optical design of the DLE product line ensures optimum homogeneity for the light distribution.

Light distribution without housing (only LED module)

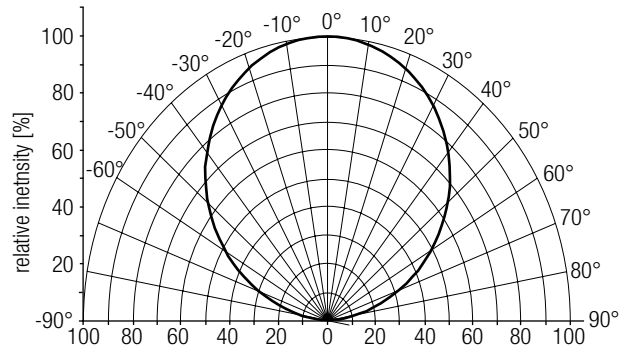

Light distribution with housing

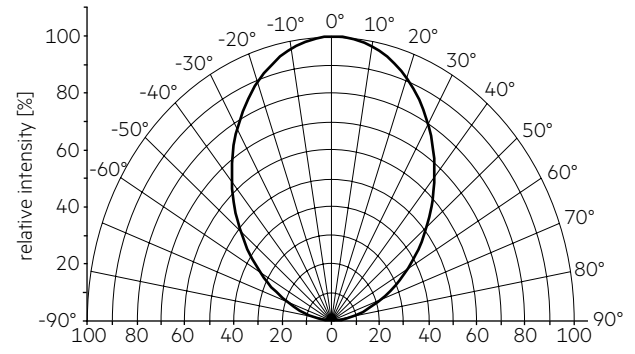

6.4 Relative luminous flux vs. tp temperature

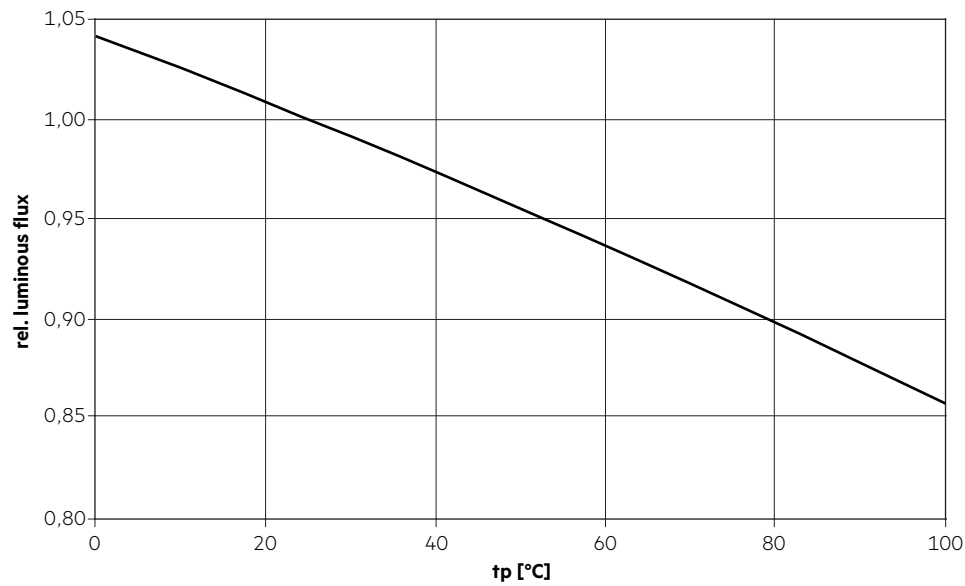

6.5 Relative luminous flux vs. operating current at $t_p = 65\text{ °C}$

DLE G4 65mm 2000lm 8x0 R ADVANCED

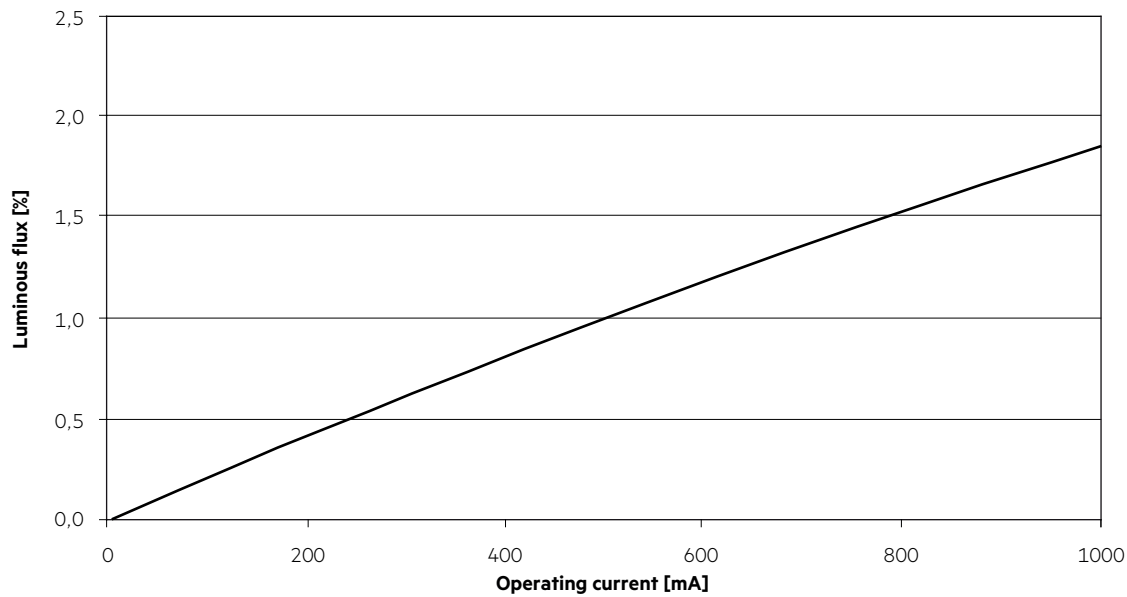

DLE G4 65mm 3000lm / 5000lm 8x0 R ADVANCED

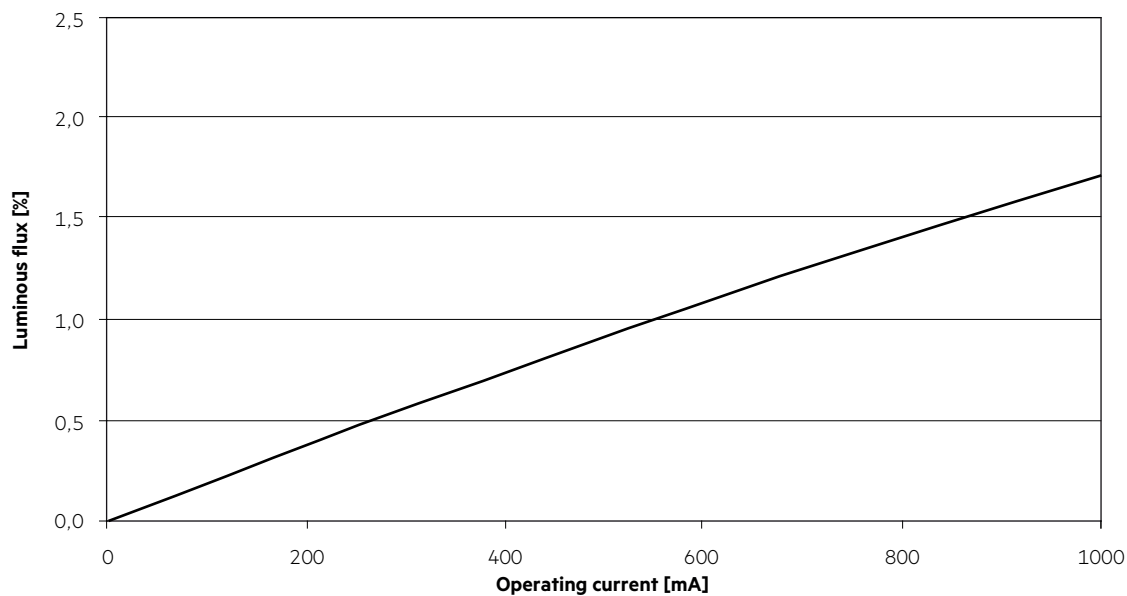

7. Miscellaneous

7.1 Additional information

Additional technical information at www.tridonic.com → Technical Data

Guarantee conditions at www.tridonic.com → Services

Life-time declarations are informative and represent no warranty claim.