



Module QLE G3+ ADV

Modules QLE ADVANCED

Product description

- Ideal for linear and panel lights
- Luminous flux range from 1,000 – 5,250 lm
- LED system solution with outstanding system efficacy up to 162 lm/W, consisting of squared LED modules and dimmable LED Driver LCA 50W 150–400mA Ip PRE
- Efficacy of the module up to 184 lm/W
- High colour rendering index CRI > 80
- Small colour tolerance MacAdam 3[®]
- Small luminous flux tolerances
- Colour temperatures 3,000, 4,000 and 5,000 K
- Perfectly uniform light, even if several LED modules are used together in a line
- Self cooling (no additional heat sink required)
- Push terminals for quick and simple wiring of LED module to LED module
- Simple installation (e.g. screws)
- Long life-time: 50,000 hours
- 5-year guarantee



Standards, page 6

Colour temperatures and tolerances, page 10



QLE G3+ 250x250mm 1250lm ADV



QLE G3+ 270x270mm 1250lm ADV

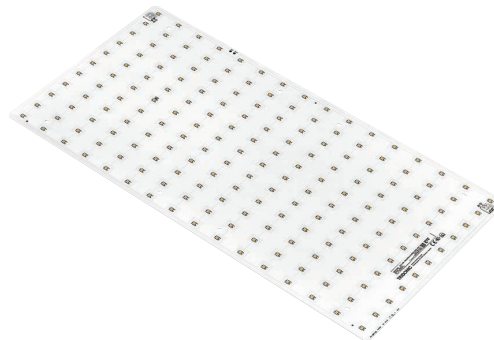

QLE G3+ 540x270mm 2500lm ADV





Module QLE G3+ ADV

Modules QLE ADVANCED

Technical data

Beam characteristic	120°
Ambient temperature range	-40 ... +65 °C
tp rated	45 °C
tc	85 °C
Irated for 250x250 / 270x270mm	250 mA
Irated for 540x270mm	500 mA
I _{max} for 250x250 / 270x270mm	900 mA
I _{max} for 540x270mm	1,800 mA
Max. permissible LF current ripple for 250x250 / 270x270mm	990 mA
Max. permissible LF current ripple for 540x270mm	1,980 mA
Max. permissible peak current for 250x250 / 270x270mm	1,500 mA / max. 10 ms
Max. permissible peak current for 540x270mm	3,000 mA / max. 10 ms
Max. working voltage for insulation ²⁾	500 V
Insulation test voltage	2 kV
CTI of the printed circuit board	≥ 600
ESD classification	severity level 4
Risk group (IEC 62471:2008) ³⁾	RG1
Classification acc. to IEC 62031	Built-in
Type of protection	IP00

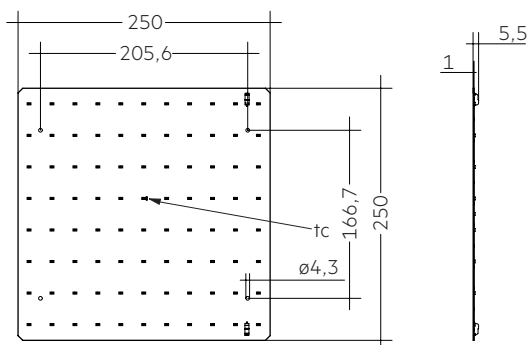

QLE G3+ 250x250mm 1250lm ADV

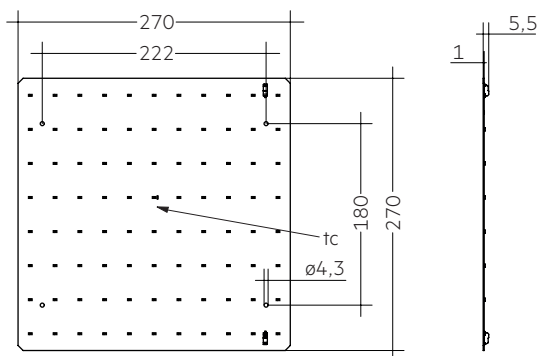

QLE G3+ 270x270mm 1250lm ADV

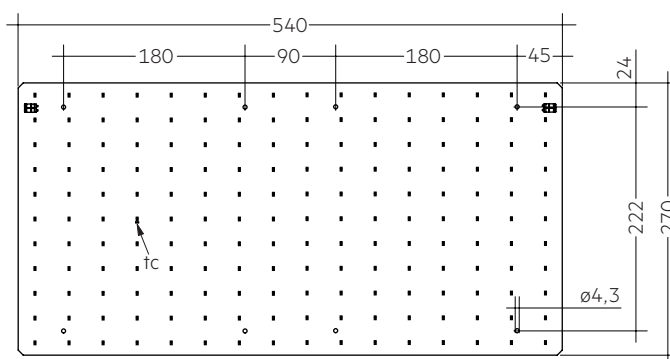

QLE G3+ 540x270mm 1250lm ADV

Ordering data

Type	Article number	Colour temperature	Packaging carton	Weight per pc.
QLE G3+ 250x250mm 1250lm 830 ADV	28001991	3,000 K	40 pc(s).	0.130 kg
QLE G3+ 250x250mm 1250lm 840 ADV	28001992	4,000 K	40 pc(s).	0.130 kg
QLE G3+ 250x250mm 1250lm 850 ADV	28001993	5,000 K	40 pc(s).	0.130 kg
QLE G3+ 270x270mm 1250lm 830 ADV	28001994	3,000 K	40 pc(s).	0.145 kg
QLE G3+ 270x270mm 1250lm 840 ADV	28001995	4,000 K	40 pc(s).	0.145 kg
QLE G3+ 270x270mm 1250lm 850 ADV	28001996	5,000 K	40 pc(s).	0.145 kg
QLE G3+ 540x270mm 2500lm 830 ADV	28001997	3,000 K	20 pc(s).	0.280 kg
QLE G3+ 540x270mm 2500lm 840 ADV	28001998	4,000 K	20 pc(s).	0.280 kg

Specific technical data

Type [®]	Photo-metric code	Typ. luminous flux at tp = 25 °C [®]	Typ. luminous flux at tp = 45 °C [®]	Typ. forward current	Min. forward voltage at tp = 45 °C	Max. forward voltage at tp = 25 °C	Typ. power consumption at tp = 45 °C [®]	Efficacy of the module at tp = 25 °C	Efficacy of the module at tp = 45 °C	Efficacy of the system at tp = 45 °C	Colour rendering index CRI
QLE G3+ 250x250 / 270x270 mm – Operating mode HE at 200 mA											
QLE G3+ 250x250mm 1250lm 830 ADV	830/359	1,030 lm	1,000 lm	200 mA	271 V	316 V	5.9 W	173 lm/W	169 lm/W	152 lm/W	> 80
QLE G3+ 250x250mm 1250lm 840 ADV	840/359	1,100 lm	1,060 lm	200 mA	271 V	316 V	5.9 W	184 lm/W	180 lm/W	162 lm/W	> 80
QLE G3+ 250x250mm 1250lm 850 ADV	850/359	1,100 lm	1,060 lm	200 mA	271 V	316 V	5.9 W	184 lm/W	179 lm/W	161 lm/W	> 80
QLE G3+ 270x270mm 1250lm 830 ADV	830/359	1,030 lm	1,000 lm	200 mA	271 V	316 V	5.9 W	173 lm/W	169 lm/W	152 lm/W	> 80
QLE G3+ 270x270mm 1250lm 840 ADV	840/359	1,100 lm	1,060 lm	200 mA	271 V	316 V	5.9 W	184 lm/W	180 lm/W	162 lm/W	> 80
QLE G3+ 270x270mm 1250lm 850 ADV	850/359	1,100 lm	1,060 lm	200 mA	271 V	316 V	5.9 W	184 lm/W	179 lm/W	161 lm/W	> 80
QLE G3+ 250x250 / 270x270 mm – Operating mode NM at 250 mA											
QLE G3+ 250x250mm 1250lm 830 ADV	830/359	1,280 lm	1,240 lm	250 mA	274 V	319 V	7.5 W	170 lm/W	166 lm/W	149 lm/W	> 80
QLE G3+ 250x250mm 1250lm 840 ADV	840/359	1,370 lm	1,320 lm	250 mA	274 V	319 V	7.5 W	181 lm/W	177 lm/W	159 lm/W	> 80
QLE G3+ 250x250mm 1250lm 850 ADV	850/359	1,370 lm	1,320 lm	250 mA	274 V	319 V	7.5 W	181 lm/W	176 lm/W	158 lm/W	> 80
QLE G3+ 270x270mm 1250lm 830 ADV	830/359	1,280 lm	1,240 lm	250 mA	274 V	319 V	7.5 W	170 lm/W	166 lm/W	149 lm/W	> 80
QLE G3+ 270x270mm 1250lm 840 ADV	840/359	1,370 lm	1,320 lm	250 mA	274 V	319 V	7.5 W	181 lm/W	177 lm/W	159 lm/W	> 80
QLE G3+ 270x270mm 1250lm 850 ADV	850/359	1,370 lm	1,320 lm	250 mA	274 V	319 V	7.5 W	181 lm/W	176 lm/W	158 lm/W	> 80
QLE G3+ 250x250 / 270x270 mm – Operating mode HO at 300 mA											
QLE G3+ 250x250mm 1250lm 830 ADV	830/359	1,520 lm	1,460 lm	300 mA	27.7 V	32.2 V	9.1 W	165 lm/W	161 lm/W	145 lm/W	> 80
QLE G3+ 250x250mm 1250lm 840 ADV	840/359	1,620 lm	1,560 lm	300 mA	27.7 V	32.2 V	9.1 W	177 lm/W	172 lm/W	155 lm/W	> 80
QLE G3+ 250x250mm 1250lm 850 ADV	850/359	1,620 lm	1,560 lm	300 mA	27.7 V	32.2 V	9.1 W	177 lm/W	171 lm/W	154 lm/W	> 80
QLE G3+ 270x270mm 1250lm 830 ADV	830/359	1,520 lm	1,460 lm	300 mA	27.7 V	32.2 V	9.1 W	165 lm/W	161 lm/W	145 lm/W	> 80
QLE G3+ 270x270mm 1250lm 840 ADV	840/359	1,620 lm	1,560 lm	300 mA	27.7 V	32.2 V	9.1 W	177 lm/W	172 lm/W	155 lm/W	> 80
QLE G3+ 270x270mm 1250lm 850 ADV	850/359	1,620 lm	1,560 lm	300 mA	27.7 V	32.2 V	9.1 W	177 lm/W	171 lm/W	154 lm/W	> 80
QLE G3+ 250x250 / 270x270 mm – Operating mode HO at 350 mA											
QLE G3+ 250x250mm 1250lm 830 ADV	830/359	1,760 lm	1,700 lm	350 mA	28.0 V	32.6 V	10.7 W	163 lm/W	159 lm/W	143 lm/W	> 80
QLE G3+ 250x250mm 1250lm 840 ADV	840/359	1,880 lm	1,810 lm	350 mA	28.0 V	32.6 V	10.7 W	174 lm/W	169 lm/W	152 lm/W	> 80
QLE G3+ 250x250mm 1250lm 850 ADV	850/359	1,880 lm	1,800 lm	350 mA	28.0 V	32.6 V	10.7 W	174 lm/W	169 lm/W	152 lm/W	> 80
QLE G3+ 270x270mm 1250lm 830 ADV	830/359	1,760 lm	1,700 lm	350 mA	28.0 V	32.6 V	10.7 W	163 lm/W	159 lm/W	143 lm/W	> 80
QLE G3+ 270x270mm 1250lm 840 ADV	840/359	1,880 lm	1,810 lm	350 mA	28.0 V	32.6 V	10.7 W	174 lm/W	169 lm/W	152 lm/W	> 80
QLE G3+ 270x270mm 1250lm 850 ADV	850/359	1,880 lm	1,800 lm	350 mA	28.0 V	32.6 V	10.7 W	174 lm/W	169 lm/W	152 lm/W	> 80
QLE G3+ 250x250 / 270x270 mm – Operating mode HO at 400 mA											
QLE G3+ 250x250mm 1250lm 830 ADV	830/359	2,000 lm	1,930 lm	400 mA	28.3 V	32.8 V	12.3 W	160 lm/W	156 lm/W	140 lm/W	> 80
QLE G3+ 250x250mm 1250lm 840 ADV	840/359	2,130 lm	2,060 lm	400 mA	28.3 V	32.8 V	12.3 W	171 lm/W	167 lm/W	150 lm/W	> 80
QLE G3+ 250x250mm 1250lm 850 ADV	850/359	2,130 lm	2,050 lm	400 mA	28.3 V	32.8 V	12.3 W	171 lm/W	166 lm/W	149 lm/W	> 80
QLE G3+ 270x270mm 1250lm 830 ADV	830/359	2,000 lm	1,930 lm	400 mA	28.3 V	32.8 V	12.3 W	160 lm/W	156 lm/W	140 lm/W	> 80
QLE G3+ 270x270mm 1250lm 840 ADV	840/359	2,130 lm	2,060 lm	400 mA	28.3 V	32.8 V	12.3 W	171 lm/W	167 lm/W	150 lm/W	> 80
QLE G3+ 270x270mm 1250lm 850 ADV	850/359	2,130 lm	2,050 lm	400 mA	28.3 V	32.8 V	12.3 W	171 lm/W	166 lm/W	149 lm/W	> 80
QLE G3+ 250x250 / 270x270 mm – Operating mode HO at 450 mA											
QLE G3+ 250x250mm 1250lm 830 ADV	830/359	2,230 lm	2,150 lm	450 mA	28.6 V	33.1 V	14.0 W	158 lm/W	154 lm/W	139 lm/W	> 80
QLE G3+ 250x250mm 1250lm 840 ADV	840/359	2,380 lm	2,300 lm	450 mA	28.6 V	33.1 V	14.0 W	168 lm/W	164 lm/W	148 lm/W	> 80
QLE G3+ 250x250mm 1250lm 850 ADV	850/359	2,380 lm	2,280 lm	450 mA	28.6 V	33.1 V	14.0 W	168 lm/W	163 lm/W	147 lm/W	> 80
QLE G3+ 270x270mm 1250lm 830 ADV	830/359	2,230 lm	2,150 lm	450 mA	28.6 V	33.1 V	14.0 W	158 lm/W	154 lm/W	139 lm/W	> 80
QLE G3+ 270x270mm 1250lm 840 ADV	840/359	2,380 lm	2,300 lm	450 mA	28.6 V	33.1 V	14.0 W	168 lm/W	164 lm/W	148 lm/W	> 80
QLE G3+ 270x270mm 1250lm 850 ADV	850/359	2,380 lm	2,280 lm	450 mA	28.6 V	33.1 V	14.0 W	168 lm/W	163 lm/W	147 lm/W	> 80
QLE G3+ 250x250 / 270x270 mm – Operating mode HO at 500 mA											
QLE G3+ 250x250mm 1250lm 830 ADV	830/359	2,460 lm	2,380 lm	500 mA	28.9 V	33.4 V	15.7 W	155 lm/W	151 lm/W	136 lm/W	> 80
QLE G3+ 250x250mm 1250lm 840 ADV	840/359	2,630 lm	2,540 lm	500 mA	28.9 V	33.4 V	15.7 W	166 lm/W	161 lm/W	145 lm/W	> 80
QLE G3+ 250x250mm 1250lm 850 ADV	850/359	2,630 lm	2,520 lm	500 mA	28.9 V	33.4 V	15.7 W	166 lm/W	161 lm/W	145 lm/W	> 80
QLE G3+ 270x270mm 1250lm 830 ADV	830/359	2,460 lm	2,380 lm	500 mA	28.9 V	33.4 V	15.7 W	155 lm/W	151 lm/W	136 lm/W	> 80
QLE G3+ 270x270mm 1250lm 840 ADV	840/359	2,630 lm	2,540 lm	500 mA	28.9 V	33.4 V	15.7 W	166 lm/W	161 lm/W	145 lm/W	> 80
QLE G3+ 270x270mm 1250lm 850 ADV	850/359	2,630 lm	2,520 lm	500 mA	28.9 V	33.4 V	15.7 W	166 lm/W	161 lm/W	145 lm/W	> 80

[®] Integral measurement over the complete module.

[®] If mounted with M4 screws.

[®] Tolerance range for optical data: +7.5 % and electrical data: ±10 %.

[®] HE ... high efficiency, NM ... nominal mode, HO ... high output.

[®] Measured at Imax.

Specific technical data

Type ^①	Photo-metric code	Typ. luminous flux at tp = 25 °C ^②	Typ. luminous flux at tp = 45 °C ^③	Typ. forward current	Min. forward voltage at tp = 45 °C	Max. forward voltage at tp = 25 °C	Typ. power consumption at tp = 45 °C ^④	Efficacy of the module at tp = 25 °C	Efficacy of the module at tp = 45 °C	Efficacy of the system at tp = 45 °C	Colour rendering index CRI
QLE G3+ 540x270mm – Operating mode HE at 400 mA											
QLE G3+ 540x270mm 2500lm 830 ADV	830/359	2,070 lm	2,000 lm	400 mA	271 V	316 V	11.8 W	173 lm/W	169 lm/W	152 lm/W	> 80
QLE G3+ 540x270mm 2500lm 840 ADV	840/359	2,210 lm	2,130 lm	400 mA	271 V	316 V	11.8 W	184 lm/W	180 lm/W	162 lm/W	> 80
QLE G3+ 540x270mm – Operating mode NM at 500 mA											
QLE G3+ 540x270mm 2500lm 830 ADV	830/359	2,570 lm	2,480 lm	500 mA	274 V	319 V	15.0 W	170 lm/W	166 lm/W	149 lm/W	> 80
QLE G3+ 540x270mm 2500lm 840 ADV	840/359	2,740 lm	2,640 lm	500 mA	274 V	319 V	15.0 W	181 lm/W	177 lm/W	159 lm/W	> 80
QLE G3+ 540x270mm – Operating mode HO at 600 mA											
QLE G3+ 540x270mm 2500lm 830 ADV	830/359	3,040 lm	2,930 lm	600 mA	277 V	322 V	18.1 W	165 lm/W	161 lm/W	145 lm/W	> 80
QLE G3+ 540x270mm 2500lm 840 ADV	840/359	3,240 lm	3,130 lm	600 mA	277 V	322 V	18.1 W	177 lm/W	172 lm/W	155 lm/W	> 80
QLE G3+ 540x270mm – Operating mode HO at 700 mA											
QLE G3+ 540x270mm 2500lm 830 ADV	830/359	3,520 lm	3,400 lm	700 mA	28.0 V	32.6 V	21.4 W	163 lm/W	159 lm/W	143 lm/W	> 80
QLE G3+ 540x270mm 2500lm 840 ADV	840/359	3,760 lm	3,620 lm	700 mA	28.0 V	32.6 V	21.4 W	174 lm/W	169 lm/W	152 lm/W	> 80
QLE G3+ 540x270mm – Operating mode HO at 800 mA											
QLE G3+ 540x270mm 2500lm 830 ADV	830/359	4,000 lm	3,860 lm	800 mA	28.3 V	32.8 V	24.7 W	160 lm/W	156 lm/W	140 lm/W	> 80
QLE G3+ 540x270mm 2500lm 840 ADV	840/359	4,270 lm	4,120 lm	800 mA	28.3 V	32.8 V	24.7 W	171 lm/W	167 lm/W	150 lm/W	> 80
QLE G3+ 540x270mm – Operating mode HO at 900 mA											
QLE G3+ 540x270mm 2500lm 830 ADV	830/359	4,460 lm	4,300 lm	900 mA	28.6 V	33.1 V	28.0 W	158 lm/W	154 lm/W	139 lm/W	> 80
QLE G3+ 540x270mm 2500lm 840 ADV	840/359	4,760 lm	4,590 lm	900 mA	28.6 V	33.1 V	28.0 W	168 lm/W	164 lm/W	148 lm/W	> 80
QLE G3+ 540x270mm – Operating mode HO at 1,000 mA											
QLE G3+ 540x270mm 2500lm 830 ADV	830/359	4,920 lm	4,750 lm	1,000 mA	28.9 V	33.4 V	31.4 W	155 lm/W	151 lm/W	136 lm/W	> 80
QLE G3+ 540x270mm 2500lm 840 ADV	840/359	5,250 lm	5,070 lm	1,000 mA	28.9 V	33.4 V	31.4 W	166 lm/W	161 lm/W	145 lm/W	> 80

^① Integral measurement over the complete module.

^② If mounted with M4 screws.

^③ Tolerance range for optical data: ±7.5 % and electrical data: ±10 %.

^④ E ... high efficiency, NM ... nominal mode, HO ... high output.

^⑤ Measured at Imax.

CLIP 4.3mm

Product description

- Clip for fixation of LED modules with 4.3 mm holes
- Fast snap on mounting (sheet thickness 0.5 – 1.0 mm for PUSH-FIX and 1 – 2 mm for PUSH-FIX Long)
- For drilling hole 4 mm
- Clip made of Polycarbonat



ACL CLIP 4.3mm PUSH-FIX

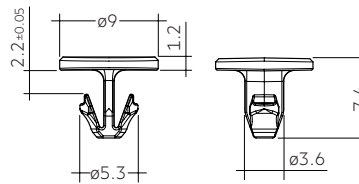

ACL CLIP 4.3mm PUSH-FIX



ACL CLIP 4.3mm PUSH-FIX Long

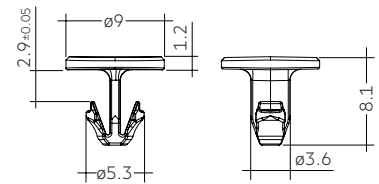

ACL CLIP 4.3mm PUSH-FIX Long

Ordering data

Type	Article number	Colour	Packaging bag [®]	Weight per pc.
ACL CLIP 4.3mm PUSH-FIX	28001036	White	500 pc(s).	0.001 kg
ACL CLIP 4.3mm PUSH-FIX Long	28002314	Transparent	500 pc(s).	0.001 kg

[®] Minimum sales quantity 500 pcs.

1. Standards

IEC 62031
IEC 62471
IEC 62778
IEC 61547
IEC 62717
UL 8750

1.1 Photometric code

Key for photometric code, e. g. 830 / 359

1 st digit	2 nd + 3 rd digit	4 th digit	5 th digit	6 th digit
Code CRI	Colour temperature in Kelvin x 100	McAdam initial	McAdam after 25% of the life-time (max.6000h)	Luminous flux after 25% of the life-time (max.6000h)
7 70 – 79				Code Luminous flux
8 80 – 89				7 ≥ 70 %
9 ≥90				8 ≥ 80 % 9 ≥ 90 %

1.2 Energy classification

Type	Energy classification
QLE G3+ ADV	A++

2. Thermal details

2.1 tc point, ambient temperature and life-time

The temperature at tp reference point is crucial for the light output and life-time of a LED product.

For QLE a tp temperature of 45 °C has to be complied in order to achieve an optimum between heat sink requirements, light output and life-time.

Compliance with the maximum permissible reference temperature at the tc point must be checked under operating conditions in a thermally stable state. The maximum value must be determined under worst-case conditions for the relevant application.

The tc and tp temperature of LED modules from Tridonic are measured at the same reference point.

2.2 Storage and humidity

Storage temperature	-40 ... +100 °C
---------------------	-----------------

Operation only in non condensing environment.

Humidity during processing of the module should be between 0 to 85 %.

2.3 Thermal design and heat sink

The rated life of LED products depends to a large extent on the temperature. If the permissible temperature limits are exceeded, the life of the QLE will be greatly reduced or the QLE may be destroyed.

3. Installation / wiring

3.1 Electrical supply/choice of LED Driver

QLE modules from Tridonic are not protected against overvoltages, overcurrents, overloads or short-circuit currents. Safe and reliable operation can only be guaranteed in conjunction with a LED Driver which complies with the relevant standards. The use of LED Driver from Tridonic in combination with QLE modules guarantees the necessary protection for safe and reliable operation.

If a LED Driver other than Tridonic is used, it must provide the following protection:

- Short-circuit protection
- Overload protection
- Overtemperature protection



QLE modules must be supplied by a constant current LED Driver. Operation with a constant voltage LED Driver will lead to an irreversible damage of the module.

Wrong polarity can damage the QLE.

With parallel wiring tolerance-related differences in output are possible (thermal stress of the module) and can cause differences in brightness. If a wire breaks or a complete module fails then the current passing through the other module increases. This may reduce its life considerably.

QLE modules can be operated either from SELV LED Drivers or from LED Drivers with LV output voltage.



QLE modules are basic isolated up to 500 V (if mounted with M4 screws with head diameter of 7 mm) against ground and can be mounted directly on earthed metal parts of the luminaire. If the max. output voltage of the led control gear (also against earth) is above 500 V, an additional isolation between LED module and heat sink is required (for example by isolated thermal pads) or by a suitable luminaire construction.

At voltages > 60 V an additional protection against direct touch (test finger) to the light emitting side of the module has to be guaranteed. This is typically achieved by means of a non removable light distributor over the module.

3.2 Wiring

QLE G3+ 250x250mm / 270x270mm:

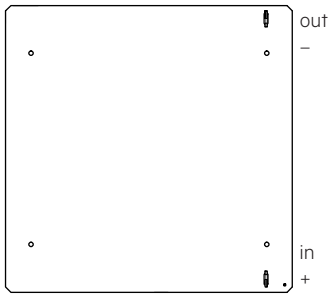

QLE G3+ 540x270mm:

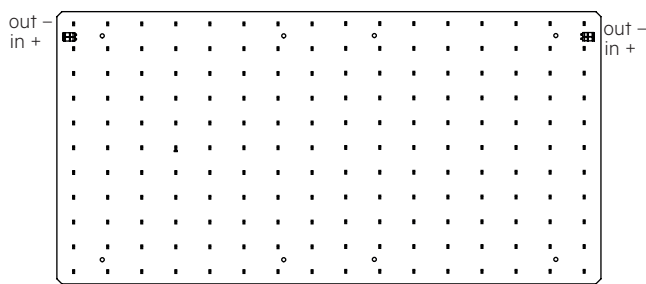

Wiring examples

QLE G3+ 250x250mm / 270x270mm:

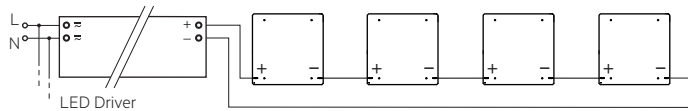

QLE G3+ 540x270mm serial wiring:

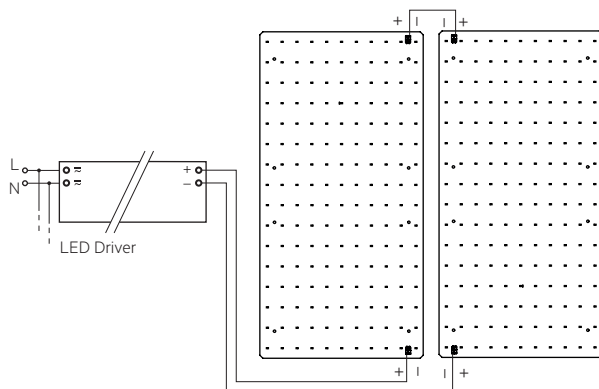

QLE G3+ 540x270mm parallell wiring:

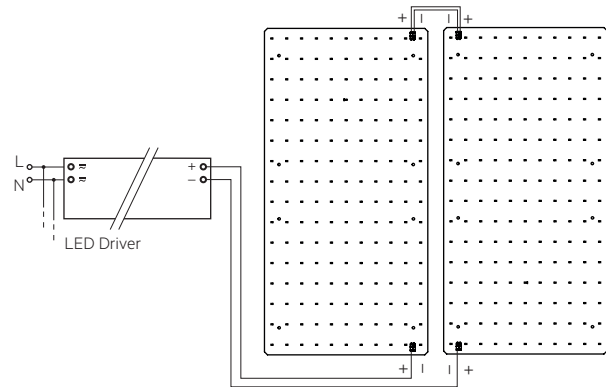

3.3 Wiring type and cross section

The wiring can be in stranded wires or solid with a cross section of 0.2 to 0.75 mm².

For the push-wire connection you have to strip the insulation (8-9 mm).

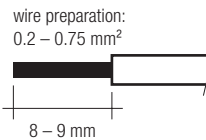

To remove the wires use a suitabel tool (e.g. Microcon release pin) or through twist and pull.

3.4 Mounting instruction

! None of the components of the QLE (substrate, LED, electronic components etc.) may be exposed to tensile or compressive stresses.

Max. torque for fixing: 0.5 Nm.

The LED modules are mounted with M4 screws or ACL CLIP 4.3mm per module.

! Chemical substance may harm the LED module. Chemical reactions could lead to colour shift, reduced luminous flux or a total failure of the module caused by corrosion of electrical connections.

Materials which are used in LED applications (e.g. sealings, adhesives) must not produce dissolver gas. They must not be condensation curing based, acetate curing based or contain sulfur, chlorine or phthalate. Avoid corrosive atmosphere during usage and storage.

3.5 EOS/ESD safety guidelines

! The device / module contains components that are sensitive to electrostatic discharge and may only be installed in the factory and on site if appropriate EOS/ESD protection measures have been taken. No special measures need be taken for devices/modules with enclosed casings (contact with the pc board not possible), just normal installation practice. Please note the requirements set out in the document EOS / ESD guidelines (Guideline_EOS_ESD.pdf) at: <http://www.tridonic.com/esd-protection>

4. Life-time

4.1 Life-time, lumen maintenance and failure rate

The light output of an LED Module decreases over the life-time, this is characterized with the L value.

L70 means that the LED module will give 70 % of its initial luminous flux. This value is always related to the number of operation hours and therefore defines the life-time of an LED module.

As the L value is a statistical value and the lumen maintenance may vary over the delivered LED modules.

The B value defines the amount of modules which are below the specific L value, e.g. L70B10 means 10 % of the LED modules are below 70 % of the initial luminous flux, respectively 90 % will be above 70 % of the initial value. In addition the percentage of failed modules (fatal failure) is characterized by the C value.

The F value is the combination of the B and C value. That means for F degradation and complete failures are considered, e.g. L70F10 means 10 % of the LED modules may fail or be below 70 % of the initial luminous flux.

4.2 Lumen maintenance for QLE

QLE G3+ 250x250mm / 270x270mm:

Forward current	tp temperature	L90 / F10	L90 / F50	L80 / F10	L80 / F50	L70 / F10	L70 / F50
250 mA	45 °C	> 60,000 h	> 60,000 h	> 60,000 h	> 60,000 h	> 60,000 h	> 60,000 h
	55 °C	41,000 h	> 60,000 h	> 60,000 h	> 60,000 h	> 60,000 h	> 60,000 h
	65 °C	31,000 h	48,000 h	> 60,000 h	> 60,000 h	> 60,000 h	> 60,000 h
	75 °C	25,000 h	38,000 h	> 60,000 h	> 60,000 h	> 60,000 h	> 60,000 h
300 mA	45 °C	38,000 h	58,000 h	> 60,000 h	> 60,000 h	> 60,000 h	> 60,000 h
	55 °C	29,000 h	44,000 h	> 60,000 h	> 60,000 h	> 60,000 h	> 60,000 h
	65 °C	22,000 h	34,000 h	52,000 h	> 60,000 h	> 60,000 h	> 60,000 h
	75 °C	17,000 h	26,000 h	41,000 h	> 60,000 h	> 60,000 h	> 60,000 h
350 mA	45 °C	28,000 h	43,000 h	60,000 h	> 60,000 h	> 60,000 h	> 60,000 h
	55 °C	21,000 h	32,000 h	47,000 h	> 60,000 h	> 60,000 h	> 60,000 h
	65 °C	16,000 h	25,000 h	37,000 h	55,000 h	57,000 h	> 60,000 h
	75 °C	13,000 h	19,000 h	30,000 h	44,000 h	46,000 h	> 60,000 h
500 mA	45 °C	14,000 h	21,000 h	28,000 h	42,000 h	41,000 h	> 60,000 h
	55 °C	10,000 h	16,000 h	22,000 h	32,000 h	33,000 h	48,000 h
	65 °C	8,000 h	12,000 h	17,000 h	26,000 h	26,000 h	39,000 h
	75 °C	6,000 h	10,000 h	14,000 h	20,000 h	21,000 h	31,000 h

QLE G3+ 540x270mm:

Forward current	tp temperature	L90 / F10	L90 / F50	L80 / F10	L80 / F50	L70 / F10	L70 / F50
500 mA	45 °C	> 60,000 h	> 60,000 h	> 60,000 h	> 60,000 h	> 60,000 h	> 60,000 h
	55 °C	41,000 h	> 60,000 h	> 60,000 h	> 60,000 h	> 60,000 h	> 60,000 h
	65 °C	31,000 h	48,000 h	> 60,000 h	> 60,000 h	> 60,000 h	> 60,000 h
	75 °C	25,000 h	38,000 h	> 60,000 h	> 60,000 h	> 60,000 h	> 60,000 h
600 mA	45 °C	38,000 h	58,000 h	> 60,000 h	> 60,000 h	> 60,000 h	> 60,000 h
	55 °C	29,000 h	44,000 h	> 60,000 h	> 60,000 h	> 60,000 h	> 60,000 h
	65 °C	22,000 h	34,000 h	52,000 h	> 60,000 h	> 60,000 h	> 60,000 h
	75 °C	17,000 h	26,000 h	41,000 h	> 60,000 h	> 60,000 h	> 60,000 h
700 mA	45 °C	28,000 h	43,000 h	60,000 h	> 60,000 h	> 60,000 h	> 60,000 h
	55 °C	21,000 h	32,000 h	47,000 h	> 60,000 h	> 60,000 h	> 60,000 h
	65 °C	16,000 h	25,000 h	37,000 h	55,000 h	57,000 h	> 60,000 h
	75 °C	13,000 h	19,000 h	30,000 h	44,000 h	46,000 h	> 60,000 h
1,000 mA	45 °C	14,000 h	21,000 h	28,000 h	42,000 h	41,000 h	> 60,000 h
	55 °C	10,000 h	16,000 h	22,000 h	32,000 h	33,000 h	48,000 h
	65 °C	8,000 h	12,000 h	17,000 h	26,000 h	26,000 h	39,000 h
	75 °C	6,000 h	10,000 h	14,000 h	20,000 h	21,000 h	31,000 h

Lumen maintenance values are based on LM80 data. Table may be updated when more recent results are available.

4.3 Switching capability

50,000 cycles

Tested according to IEC 62717 Cl 10.3.3
30 s on / 30 s off at I_{max}

5. Electrical values

5.1 Declaration of electrical parameters

Irated ... Nominal operating current the module is designed for.

I_{max} ... Max. permissible continuous operating current incl. the tolerances of the LED Driver.

Max. permissible LF current ripple ... Max. output current of the LED driver incl. Tolerances and LF current ripple must not exceed this value.

Max. permissible peak current ... The max. output peak current of the LED driver must not exceed this value.

5.2 Typ. forward voltage vs. forward current

QLE G3+ 250x250mm / 270x270mm:

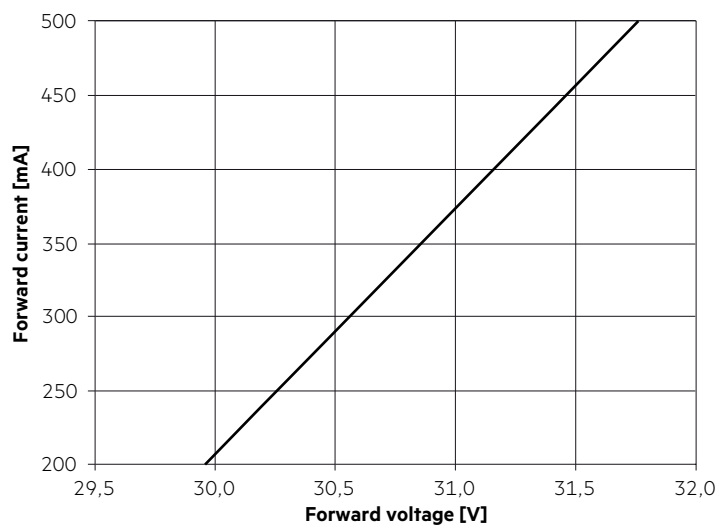

QLE G3+ 540x270mm:

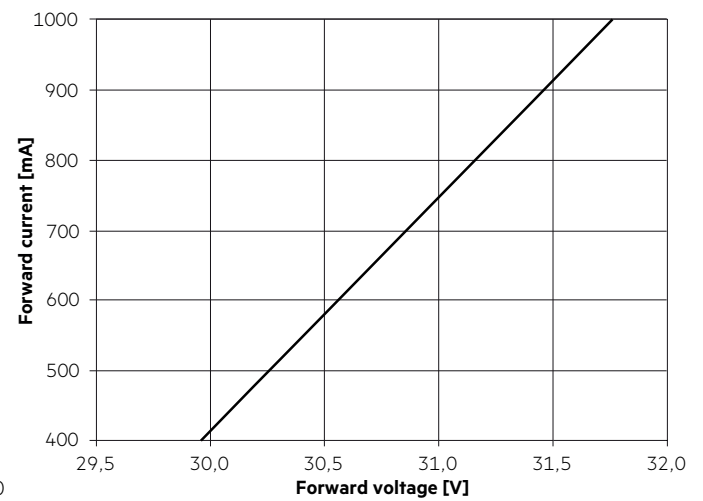

5.2 Forward voltage vs. tp temperature

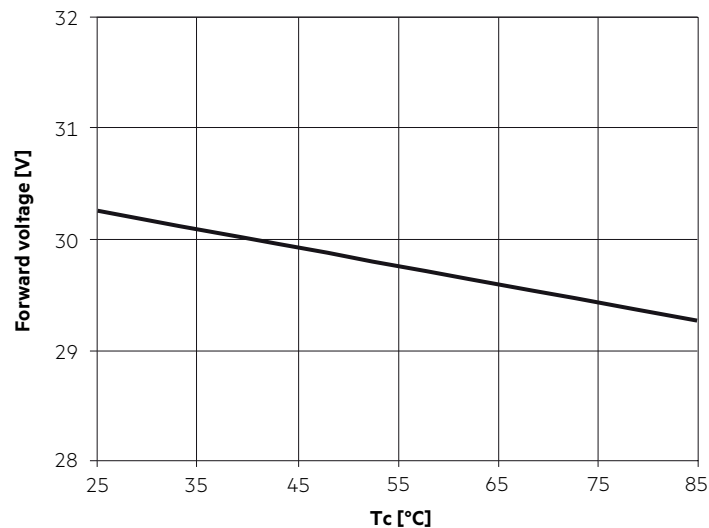

The diagrams are based on statistic values.
The real values can be different.

6. Photometric characteristics

6.1 Coordinates and tolerances according to CIE 1931

The specified colour coordinates are measured integral by a current impulse of 250 / 500 mA and a duration of 100 ms.

The ambient temperature of the measurement is $t_a = 25^\circ\text{C}$.

The measurement tolerance of the colour coordinates are ± 0.01 .

3,000 K

	x0	y0
Centre	0.4352	0.4041

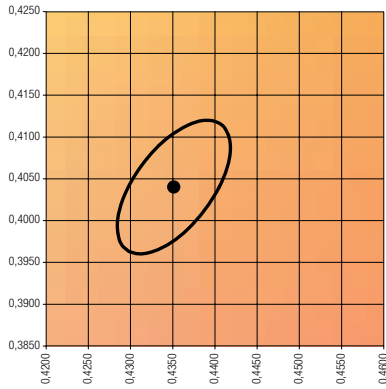

— MacAdam Ellipse: 3SDCM

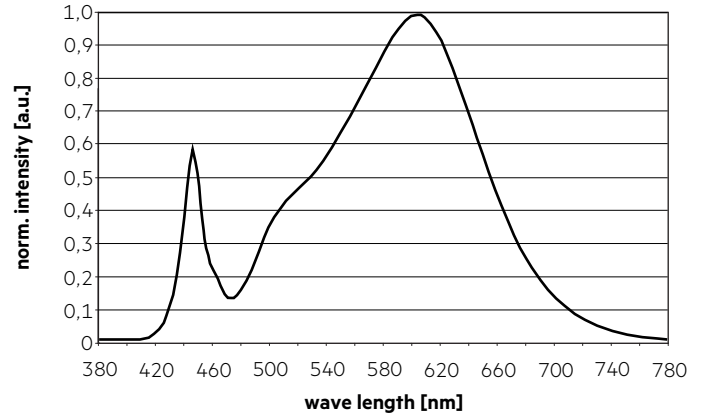

4,000 K

	x0	y0
Centre	0.3834	0.3812

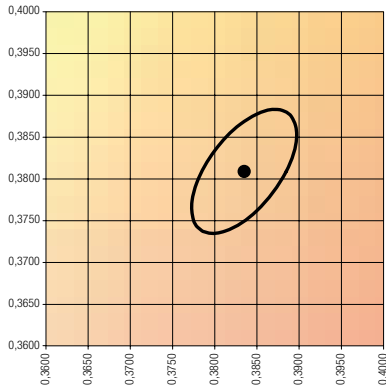

— MacAdam Ellipse: 3SDCM

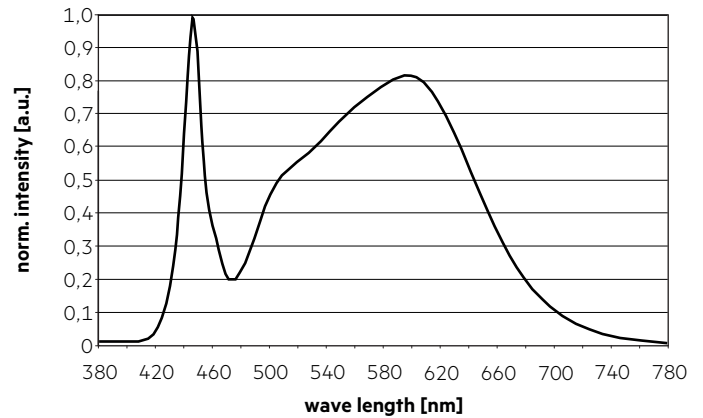

5,000 K

	x0	y0
Centre	0.3459	0.3566

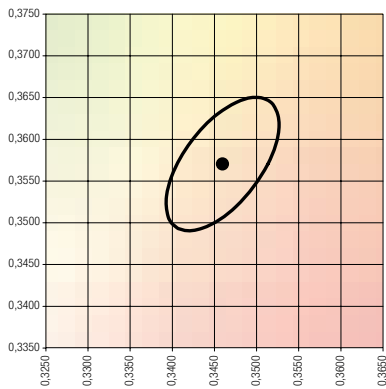

— MacAdam Ellipse: 3SDCM

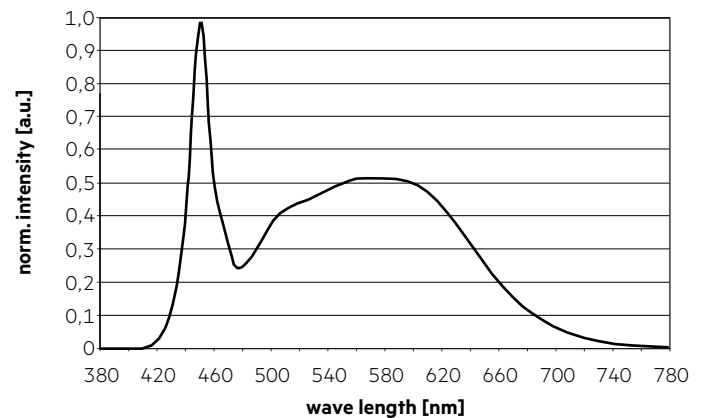

6.2 Light distribution

The optical design of the QLE product line ensures optimum homogeneity for the light distribution.

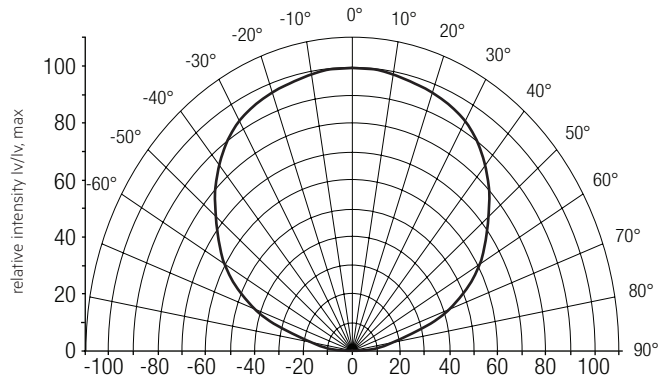

The colour temperature is measured integral over the complete module. The single LED light points can have deviations in the colour coordinates within MacAdam tbd. To ensure an ideal mixture of colours and a homogenous light distribution a suitable optic (e. g. PMMA diffuser) and a sufficient spacing between module and optic (typ. 6 cm) should be used.

6.3 Relative luminous flux vs. tc temperature

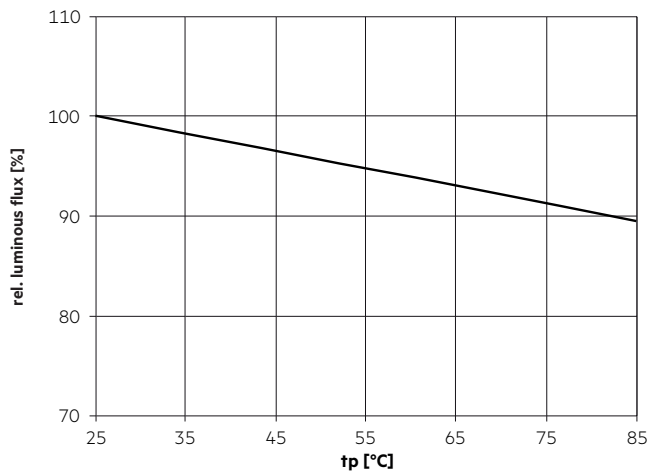

6.4 Relative luminous flux vs. operating current

QLE G3+ 250x250mm / 270x270mm:

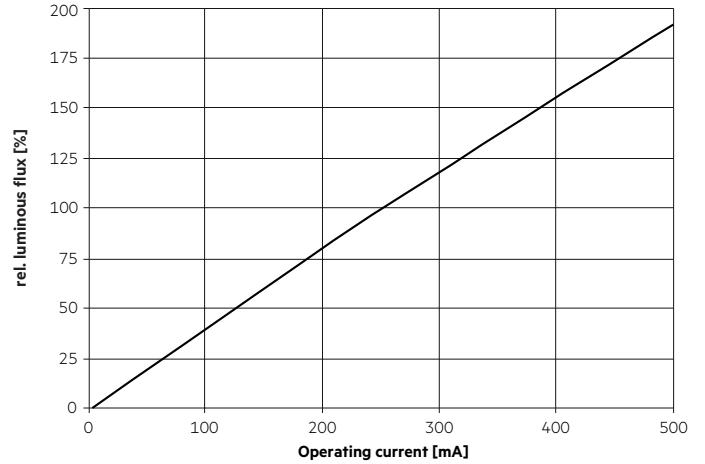

QLE G3+ 540x270mm:

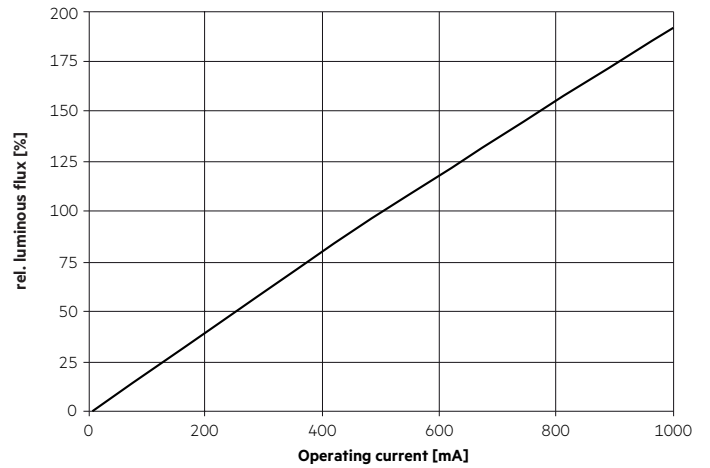

7. Miscellaneous

7.1 Additional information

Additional technical information at www.tridonic.com → Technical Data

Guarantee conditions at www.tridonic.com → Services

Life-time declarations are informative and represent no warranty claim.