

EM BASIC, 230 – 240 V 50/60 Hz

BASIC version

Product description

- Emergency lighting supply unit for manual testing
- For linear and compact fluorescent lamps
- Small dimensions (28 x 39 mm cross-section)
- 5-year guarantee

Properties

- 1 or 3 h rated duration
- Compatible with all electronic ballasts (dimnable and non-dimnable)
- Can also be used in combination with conventional magnetic ballasts
- 5-pole technology: 4-pole lamp changeover and delayed power switching for the ballast
- Optimised AC output voltage for TC-DD and TC-L lamps
- Optimised DC output voltage for T8 lamps
- Cathode heating adapted for compact lamps
- Switchover relay with high-current contacts
- IDC (insulation displacement connection)
- Green charge status display LED
- Checking the emergency lighting function by interrupting the unswitched phase
- Optional test switch
- Deep discharge protection
- Battery connection, short-circuit protected (not reversible)
- No polarity reversal protection for battery

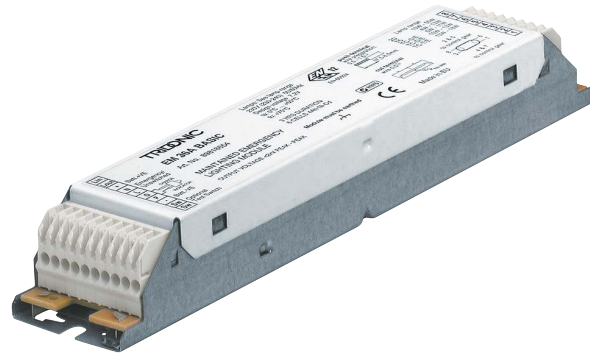

Batteries

- High-temperature cells
- NiCd batteries
- D or Cs cells
- Blade terminals for simple connection
- 4-year design life
- 1-year guarantee
- For battery compatibility refer to chapter „Ballast-Lumen-Factor (BLF)“



Standards, page 12

Wiring diagrams and installation examples, page 14



EM BASIC, 230 – 240 V 50/60 Hz

BASIC version

Technical data

Rated supply voltage	230 – 240 V
Mains frequency	50 / 60 Hz
Mains current	0.04 A
Rated power	7 W
Battery charging time	24 h
Discharge current ^①	see page 11 / 12
Charge current Cs cells ^②	120 mA
Charge current D cells ^②	210 mA
Leakage current (PE)	0.5 mA
Ambient temperature ta	0 ... +50 °C
Max. casing temperature tc	75 °C
Mains voltage changeover threshold	according to EN 60598-2-22
Min. lamp starting temperature (emergency mode)	0 °C
Type of protection	IP20

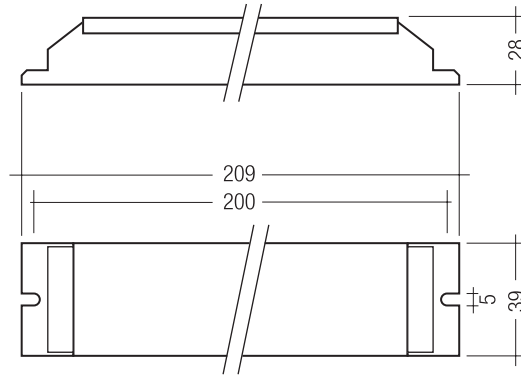

Ordering data

Type ^③	Article number	Number of cells	Packaging, carton	Packaging, pallet	Weight per pc.
Rated operating time 3 h					
EM 33A BASIC	89818556	3	25 pc(s).	750 pc(s).	0.337 kg
EM 33B BASIC	89818655	3	25 pc(s).	750 pc(s).	0.311 kg
EM 33C BASIC	89800000	3	25 pc(s).	750 pc(s).	0.337 kg
EM 34A BASIC	89818557	4	25 pc(s).	750 pc(s).	0.337 kg
EM 34B BASIC	89818662	4	25 pc(s).	750 pc(s).	0.324 kg
EM 34C BASIC	89800107	4	25 pc(s).	750 pc(s).	0.310 kg
EM 34D BASIC	89800175	4	25 pc(s).	750 pc(s).	0.318 kg
EM 35A BASIC	89818581	5	25 pc(s).	750 pc(s).	0.337 kg
EM 35B BASIC	89818667	5	25 pc(s).	750 pc(s).	0.311 kg
EM 35C BASIC	89800001	5	25 pc(s).	750 pc(s).	0.315 kg
EM 35D BASIC	89899621	5	25 pc(s).	750 pc(s).	0.337 kg
EM 36A BASIC	89818654	6	25 pc(s).	750 pc(s).	0.337 kg
EM 36C BASIC	89800108	6	25 pc(s).	750 pc(s).	0.337 kg
EM 36C HO BASIC	89800109	6	25 pc(s).	750 pc(s).	0.337 kg
Rated operating time 1 h					
EM 13B BASIC	89895971	3	25 pc(s).	750 pc(s).	0.337 kg
EM 13E BASIC	89899864	3	25 pc(s).	750 pc(s).	0.337 kg
EM 14B BASIC	89899611	4	25 pc(s).	750 pc(s).	0.337 kg
EM 14C BASIC	89800118	4	25 pc(s).	750 pc(s).	0.318 kg
EM 16C BASIC	89800119	6	25 pc(s).	750 pc(s).	0.337 kg
EM 16C HO BASIC	89800120	6	25 pc(s).	750 pc(s).	0.337 kg

^① EM 34B BASIC also available in 110 V AC version

^② Tolerance ± 15 % at 230 V

^③ EM = Emergency

ACCESSORIES

Test switch EM2

Product description

- For connection to the emergency lighting unit
- For checking the device function



Ordering data

Type	Article number	Packaging, bag	Packaging, carton	Weight per pc.
Test switch EM 2	89805277	25 pc(s).	600 pc(s).	0.011 kg

ACCESSORIES

Status indication green LED

Product description

- A green LED indicates that charging current is flowing into the battery



Ordering data

Type	Article number	Packaging, bag	Packaging, carton	Weight per pc.
LED EM green	89899605	25 pc(s).	200 pc(s).	0.011 kg
LED EM green, ultra high brightness	89899756	25 pc(s).	800 pc(s).	0.012 kg

Ballast Lumen Factor (BLF) in %

EM BASIC for linear lamps, 1 h

	1 h	3 cells		4 cells		6 cells	
	Type	EM 13B BASIC	EM 13E BASIC	EM 14B BASIC	EM 14C BASIC	EM 16C BASIC	EM 16C HO BASIC
	Article no.	89895971	89899864	89899611	89800118	89800119	89800120
Lamp type	Wattage	BLF in emergency lighting mode in % for rated operating time					
T5	14 W				18.9		
	21 W					14.4	
	24 W				13.5		
	28 W					12.7	
	35 W					12	
	49 W					9.5	
	54 W						6.4
	80 W						4.5
T8	18 W	22.5		25			
	36 W	15.5		18.2			
	58 W		8.9	13.9			

Technology and capacity	Design	Number of cells	Type	Article no.	Assignable batteries				
NiCd 4 Ah D cells	Stick	3	Accu-NiCd 3A	89895960	•	•			
	side by side	3	Accu-NiCd 3B 55	89800384	•	•			
	Stick	4	Accu-NiCd 4A 55	89800089			•		
	side by side	4	Accu-NiCd 4B 55	89800385			•		
	Stick + Stick	2+2	Accu-NiCd 4C	89895978			•		
	Stick + Stick	3+3	Accu-NiCd 6C 55	89800388					
NiCd 1.6 Ah Cs cells	Stick	4	Accu-NiCd C4A	89899692				•	
	Stick + Stick	2 + 2	Accu-NiCd C4C	89899694				•	
	side by side	4	Accu-NiCd C4B	89899693				•	
	Stick	6	Accu-NiCd C6A	89899698				•	•
	Stick + Stick	3 + 3	Accu-NiCd C6C	89899699				•	•

Ballast Lumen Factor (BLF) in %

EM BASIC for linear lamps, 3 h

	3 h	3 cells			4 cells			
		Type	EM 33A BASIC	EM 33B BASIC	EM 33C BASIC	EM 34A BASIC	EM 34B BASIC	EM 34C BASIC
		Article no.	89818556	89818655	89800000	89818557	89818662	89800107
Lamp type	Wattage	BLF in emergency lighting mode in % for rated operating time						
T5	6 W	21.5			26			
	8 W	23			28			
	13 W	20			26			
	14 W	16			21		18.9	
	21 W							
	24 W						13.5	
	28 W							
	35 W							
	49 W							
	54 W							
	80 W							
T8	18 W		10			12		
	30 W		8.2			11.5		
	36 W		7.4			8.5		
	58 W					7.2		
	70 W							

Technology and capacity	Design	Number of cells	Type	Article no.	Assignable batteries				
NiCd 4 Ah D cells	Stick	3	Accu-NiCd 3A	89895960	•	•	•		
	side by side	3	Accu-NiCd 3B 55	89800384	•	•	•		
	Stick	4	Accu-NiCd 4A 55	89800089				•	•
	side by side	4	Accu-NiCd 4B 55	89800385				•	•
	Stick + Stick	2 + 2	Accu-NiCd 4C	89895978				•	•
	Stick	5	Accu-NiCd 5A	89895973					
	Stick + Stick	3 + 2	Accu-NiCd 5C 55	89800090					
	Stick + Stick	3 + 3	Accu-NiCd 6C 55	89800388					

Ballast Lumen Factor (BLF) in %

EM BASIC for linear lamps, 3 h

	3 h	5 cells		6 cells			
		Type	EM 35A BASIC	EM 35B BASIC	EM 36A BASIC	EM 36C BASIC	EM 36C HO BASIC
		Article no.	89818581	89818667	89818654	89800108	89800109
Lamp type	Wattage	BLF in emergency lighting mode in % for rated operating time					
T5	6 W	34		38,5			
	8 W	37		39,5			
	13 W	35,5		41			
	14 W	28,5					
	21 W				14,4		
	24 W	19					
	28 W				12,7		
	35 W				12		
	49 W				9,5		
	54 W					6,4	
	80 W					4,5	
T8	18 W	18	13,2				
	30 W	12,5	12,5				
	36 W	15,3	10				
	58 W		7,3				
	70 W		7,5				

Technology and capacity	Design	Number of cells	Type	Article no.	Assignable batteries				
NiCd 4 Ah D cells	Stick	3	Accu-NiCd 3A	89895960					
	side by side	3	Accu-NiCd 3B 55	89800384					
	Stick	4	Accu-NiCd 4A 55	89800089					
	side by side	4	Accu-NiCd 4B 55	89800385					
	Stick + Stick	2 + 2	Accu-NiCd 4C	89895978					
	Stick	5	Accu-NiCd 5A	89895973	•	•			
	Stick + Stick	3 + 2	Accu-NiCd 5C 55	89800090	•	•			
	Stick + Stick	3 + 3	Accu-NiCd 6C 55	89800388			•	•	•

Ballast Lumen Factor (BLF) in %

EM BASIC for compact lamps, 3 h

		3 h	3 cells			4 cells		
		Type	EM 33A BASIC	EM 33B BASIC	EM 33C BASIC	EM 34A BASIC	EM 34B BASIC	EM 34D BASIC
		Article no.	89818556	89818655	89800000	89818557	89818662	89800175
Lamp type	Wattage	BLF in emergency lighting mode in % for rated operating time						
TC-DD	16 W	16.3				21		
	21 W	15.3				19		
	28 W					15.4		
	38 W							
	55 W							
TC-SEL	7 W				15			
	9 W				16.5			
	11 W				17.5			
TC-DEL	13 W				15.4			
	18 W							
	26 W			6.7			8.5	
TC-TEL	13 W				12.3			
	18 W							
	26 W			6.7			7.5	
	32 W							
	42 W							
TC-L	18 W	10.5				13.5		
	24 W					13.2		
	36 W						7.5 [Ⓞ]	
	40 W							7.3
	55 W							6

Technology and capacity	Design	Number of cells	Type	Article no.	Assignable batteries				
NiCd 4 Ah D cells	Stick	3	Accu-NiCd 3A	89895960	•	•	•		
	side by side	3	Accu-NiCd 3B 55	89800384	•	•	•		
	Stick	4	Accu-NiCd 4A 55	89800089				•	•
	side by side	4	Accu-NiCd 4B 55	89800385				•	•
	Stick + Stick	2 + 2	Accu-NiCd 4C	89895978				•	•
	Stick	5	Accu-NiCd 5A	89895973					
	Stick + Stick	3 + 2	Accu-NiCd 5C 55	89800090					
	Stick + Stick	3 + 3	Accu-NiCd 6C 55	89800388					

Note: Not for use with TC-D / TC-T compact amalgam lamps.

[Ⓞ] Used only in maintained mode because mercury migration may occur during emergency operation.

Ballast Lumen Factor (BLF) in %

EM BASIC for compact lamps, 3 h

	3 h	5 cells			6 cells	
		Type	EM 35A BASIC	EM 35C BASIC	EM 35D BASIC	EM 36A BASIC
		Art. Nr.	89818581	89800001	89899621	89818654
Lamp type	Wattage	BLF in emergency lighting mode in % for rated operating time				
TC-DD	16 W	27			31	
	21 W	26			28	
	28 W	20			24	
	38 W	17			19.3	
	55 W				13	
TC-SEL	7 W					
	9 W					
	11 W					
TC-DEL	13 W		16.2			
	18 W		13.4			
	26 W		11.8			
TC-TEL	13 W		15.5			
	18 W		11.8			
	26 W		11			
	32 W			6.7		
	42 W			5.4		
TC-L	18 W	18			20	
	24 W	17.5			19.5	
	36 W	16.5			18.5	
	40 W					
	55 W					

Technology and capacity	Design	Number of cells	Type	Article no.	Assignable batteries			
NiCd 4 Ah D cells	Stick	3	Accu-NiCd 3A	89895960				
	side by side	3	Accu-NiCd 3B 55	89800384				
	Stick	4	Accu-NiCd 4A 55	89800089				
	side by side	4	Accu-NiCd 4B 55	89800385				
	Stick + Stick	2+2	Accu-NiCd 4C	89895978				
	Stick	5	Accu-NiCd 5A	89895973	•	•	•	
	Stick + Stick	3+2	Accu-NiCd 5C 55	89800090	•	•	•	
	Stick + Stick	3+3	Accu-NiCd 6C 55	89800388				•

Note: Not for use with TC-D / TC-T compact amalgam lamps.

Emergency Ballast Lumen Factor (EBLF) in %

EM BASIC, 1 h

	Duration	1 h					
		3 cells		4 cells		6 cells	
Type		EM 13B BASIC	EM 13E BASIC	EM 14B BASIC	EM 14C BASIC	EM 16C BASIC	EM16C HO BASIC
Article no.		89895971	89899864	89899611	89800118	89800119	89800120
Lamp type	Wattage	EBLF in emergency lighting mode in % for rated operating time					
T5 FH	14 W				16.6		
	21 W					12.4	
	28 W					11	
	35 W					10.3	
T5 FQ	24 W				12.2		
	49 W					8.2	
	54 W						4
	80 W						3.8
T8	18 W	19.7		22.2			
	36 W						
	58 W		7.6				

EM BASIC discharge current in Ampere [A]

EM BASIC, 1 h

	Duration	1 h					
		3 cells		4 cells		6 cells	
Type		EM 13B BASIC	EM 13E BASIC	EM 14B BASIC	EM 14C BASIC	EM 16C BASIC	EM16C HO BASIC
Article no.		89895971	89899864	89899611	89800118	89800119	89800120
Lamp type	Wattage	Discharge current in Ampere [A] for rated operating time					
T5 FH	14 W				1.1		
	21 W					0.8	
	28 W					1	
	35 W					1.1	
T5 FQ	24 W				1.1		
	49 W					1	
	54 W						1.1
	80 W						1.1
T8	18 W	1.6		1.3			
	36 W						
	58 W		2.2				

Notes:

- Tolerance $\pm 15\%$ at 230 V
- Low battery voltage cut off (LBVCO) = 0.8 V per cell

Emergency Ballast Lumen Factor (EBLF) in %

EM BASIC, 3 h

Duration		3 h													
Cells	3 cells	3 cells	3 cells	4 cells	4 cells	4 cells	4 cells	5 cells	5 cells	5 cells	5 cells	6 cells	6 cells	6 cells	
Type	EM 33A BASIC	EM 33B BASIC	EM 33C BASIC	EM 34A BASIC	EM 34B BASIC	EM 34C BASIC	EM 34D BASIC	EM 35A BASIC	EM 35B BASIC	EM 35C BASIC	EM 35D BASIC	EM 36A BASIC	EM 36C BASIC	EM 36C HO BASIC	
Article no.	89818556	89818655	89800000	89818557	89818662	89800107	89800175	89818581	89818667	89800001	89899621	89818654	89800108	89800109	
Lamp type	Wattage														
	EBLF in emergency lighting mode in % for rated operating time														
T5	6 W	18.5			23			30					33.5		
	8 W	20.5			25			32.5					35		
	13 W	17.5			23			30.5					34		
T5 FH	14 W	13.3			21		16.6	25.6							
	21 W												12.4		
	28 W												11		
	35 W												10.3		
T5 FQ	24 W						12.2								
	49 W												8.2		
	54 W													4	
	80 W													3.8	
T8	18 W		9.4			10.9		16.8	11.9						
	30 W		7.6			10.3		16.7	11.2						
	36 W		6.9			7.8		13.9	9						
	58 W					6.1			6.7						
	70 W		6.3						6.3						
TC-DD	16 W	14			18.3			23.1					27.2		
	21 W	13.1			16.3			21					24.5		
	28 W				13.2			16.2					20.5		
	38 W							14.5					16.5		
	55 W												10.1		
TC-SEL	7 W			12.7											
	9 W			14.0											
	11 W			15.0											
TC-DEL	13 W			12.7						13.2					
	18 W									11.9					
	26 W		5.8			6.6				10.4					
TC-TEL	13 W			10.2						13.9					
	18 W									10.4					
	26 W		6.2			6.9				9.9					
	32 W										6.3				
	42 W										4.8				
TC-L	18 W	9.2			12			15.9					17.5		
	24 W				11.3			15.2					17		
	36 W					6.3		14.5					16.7		
	40 W						6.5								
	55 W						5.3								

Discharge current in Ampere [A]

EM BASIC, 3 h

Duration	3 h														
	3 cells	3 cells	3 cells	4 cells	4 cells	4 cells	4 cells	5 cells	5 cells	5 cells	5 cells	6 cells	6 cells	6 cells	
Type	EM 33A BASIC	EM 33B BASIC	EM 33C BASIC	EM 34A BASIC	EM 34B BASIC	EM 34C BASIC	EM 34D BASIC	EM 35A BASIC	EM 35B BASIC	EM 35C BASIC	EM 35D BASIC	EM 36A BASIC	EM 36C BASIC	EM 36C HO BASIC	
Article no.	89818556	89818655	89800000	89818557	89818662	89800107	89800175	89818581	89818667	89800001	89899621	89818654	89800108	89800109	
Lamp type	Wattage														
	Discharge current in Ampere [A] for rated operating time														
T5	6 W	0.51			0.49				0.5				0.47		
	8 W	0.74			0.65				0.65				0.6		
	13 W	1			0.93				0.95				0.9		
T5 FH	14 W	1.1			0.8		1.1		1						
	21 W													0.8	
	28 W													1	
	35 W													1.1	
T5 FQ	24 W						1.1								
	49 W													1	
	54 W														1.1
	80 W														1.1
T8	18 W		0.8			0.7			0.8	0.6					
	30 W		1.1			1			1.1	0.8					
	36 W		0.8			0.7									
	58 W					1.1				1.1					
	70 W		1.06							1.06					
TC-DD	16 W	1.05			0.94				0.94				0.86		
	21 W	1.07			0.95				0.97				0.89		
	28 W				1.13				1.14				1.09		
	38 W								1.22				1.14		
	55 W												1.11		
TC-SEL	7 W			0.79											
	9 W			0.9											
	11 W			1.11											
TC-DEL	13 W			1.1						0.74					
	18 W									0.9					
	26 W		0.7			0.7				1.1					
TC-TEL	13 W			1.1						0.7					
	18 W									0.9					
	26 W		0.8			0.7				1.1					
	32 W											1.0			
	42 W											1.3			
TC-L	18 W	0.76			0.69				0.71				0.65		
	24 W	0.91			0.94				0.86						
	36 W					0.82			1.15				1.1		
	40 W							1.1							
	55 W							1.1							

Notes:

- Tolerance $\pm 15\%$ at 230 V
- Low battery voltage cut off (LBVCO) = 0.8 V per cell

Standards

- according to EN 50172
- according to EN 60598-2-22
- EN 61347-2-7
- EN 55015
- EN 61000-3-2
- EN 61000-3-3
- EN 61547
- EN 60068-2-64
- EN 60068-2-29
- EN 60068-2-30



Note:

The EM BASIC is not intended to be used for high risk task area lighting.

Isolation and electric strength testing of luminaires

Electronic devices can be damaged by high voltage. This has to be considered during the routine testing of the luminaires in production.

According to IEC 60598-1 Annex Q (informative only!) or ENEC 303-Annex A, each luminaire should be submitted to an isolation test with 500 VDC for 1 second. This test voltage should be connected between the interconnected phase and neutral terminals and the earth terminal. The isolation resistance must be at least 2 MΩ.

As an alternative, IEC 60598-1 Annex Q describes a test of the electrical strength with 1,500 VAC (or 1,414 x 1,500 VDC). To avoid damage to the electronic devices this test must not be conducted.

Note: Basic insulation between supply and battery circuit.

Technical data batteries

Accu-NiCd

1.6 Ah

Battery voltage/cell	1.2 V
Cell type	Cs
Case temperature range to ensure 4 years design life	+5 °C to +50 °C
Max. short term temperature (reduced life-time)	70 °C
Max. number discharge cycles	4 cycles per year plus 4 cycles during commissioning
Max. storage time	6 months

4.2 / 4.5 Ah

Battery voltage/cell	1.2 V
Cell type	D
Case temperature range to ensure 4 years design life	+5 °C to +55 °C
Max. short term temperature (reduced life-time)	70 °C
Max. number discharge cycles	4 cycles per year plus 4 cycles during commissioning
Max. storage time	6 months

For further informations refer to corresponding battery datasheet.

Storage, installation and commissioning

Relevant information about storage conditions, installation and commissioning are provided in the battery datasheets.

Connection method: 4.8 x 0.5 mm spade welded to end of cell

For the stick batteries this connection is accessible after the battery end caps have been fitted.

To inhibit inverter operation, only disconnect the batteries by removing the connector from the battery spade tags.

Electrical connections

An earthed starting aid is recommended. The module should be earthed by the fixings used to attach it to the luminaire.

Terminal block type:

Push wire and insulation displacement

Terminal block capacity

- Push wire: 0.5 to 1.5 mm² solid conductor
- Insulation displacement: 0.5 mm² solid conductor

Wire strip length: 7.5 to 8.5 mm

Lamp lead length: 2,500 mm max.

The longer pair of leads should always be connected to terminals 3 and 8.

Life-time

Average life-time 50,000 hours under rated conditions with a failure rate less than 10 %. Average failure rate of 0.2 % per 1,000 operating hours

Mechanical details

Channel manufactured from 0.4 mm Galvalite galvanised steel.

Cover manufactured from 0.4 mm white pre-coated steel.

LED status indicator

- Green
- Mounting hole 6.5 mm diameter
- Lead length 750 mm (Bezel supplied fitted to LED)
- Insulation rating: 90 °C

Test switch

- Mounting hole 7 mm diameter
- Length of test switch lead 550 mm

Battery leads

- Quantity: 1 red and 1 black
- Length: 1000 mm (Accu NiCd 3B, 4B, 4C), 1300 mm (all others)
- Wire type: 0.5 mm² solid conductor
- Insulation temperature rating: 90 °C

Termination 1

Push on 4.8 mm receptacle to suit battery spade fitted with insulating cover

Termination 2

9 mm stripped insulation

Two-piece batteries are supplied with a 200 mm lead with 4.8 mm receptacle at each end and insulating covers to connect the separate sticks together.

Wiring guidelines

To ensure that a luminaire containing high frequency emergency units complies with EN 55015 for radio frequency conducted interference in both normal and emergency mode it is essential to follow good practice in the wiring layout.

Within the luminaire the switched and unswitched 50 Hz supply wiring must be routed as short as possible and be kept as far away as possible from the lamp leads.

This means, for example, in a linear T8 or T5 luminaire the mains wiring should be routed along one side of the luminaire body, while the wires to the emergency lamp from the emergency module are routed along the other side.

The high frequency emergency lamp wiring contains "hot" leads at pins 1 and 6, which have high voltage to earth. These should be kept as short as possible and separated from other wiring to minimize coupling. They also have a restriction on capacitance to other wiring and earth of 100 pF, which must be observed to ensure good lamp starting.

With an earth connection of the metal case of the emergency module the noise suppression can be further improved. The wiring of the earth should be kept as short as possible.

Through wiring may affect the emc performance of the luminaire.

With the use of the fifth pole possible compatibility problems between the products can be prevented. Depending on the luminaire wiring the radio suppression in the emergency mode of operation can be further improved.

Capacitive loading limits of lamp leads must not be exceeded. Note the capacitance of the emergency lamp leads adds to the capacitance of the leads from the ballast to the EM BASIC module when considering ballast loading.

To avoid the damage of the control gear, the wiring must be protected against short circuits to earth (sharp edged metal parts, metal cable clips, louver, etc.).

Working voltage (Uout)

Type	Uout [®]
EM 33A BASIC	250 / 250 V
EM 33B BASIC	250 / 250 V
EM 33C BASIC	250 / 250 V
EM 34A BASIC	250 / 250 V
EM 34B BASIC	250 / 250 V
EM 34C BASIC	250 / 250 V
EM 34D BASIC	250 / 250 V
EM 35A BASIC	250 / 250 V
EM 35B BASIC	250 / 250 V
EM 35C BASIC	250 / 250 V
EM 35D BASIC	250 / 250 V
EM 36A BASIC	250 / 250 V
EM 36C BASIC	400 / 400 V
EM 36C HO BASIC	350 / 350 V
EM 13B BASIC	250 / 250 V
EM 13E BASIC	300 / 300 V
EM 14B BASIC	250 / 250 V
EM 14C BASIC	250 / 250 V
EM 16C BASIC	320 / 320 V
EM 16C HO BASIC	350 / 350 V

[®] Max. voltage between output terminals / Max. voltage between output terminal to earth

Circuit diagrams

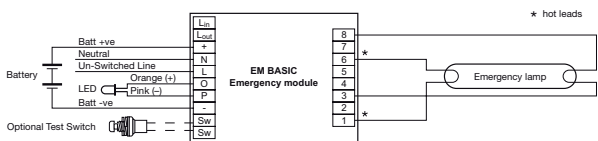

Non maintained

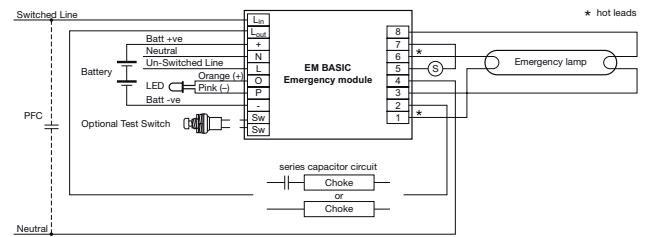

Single lamp switch start circuit with conventional control gear

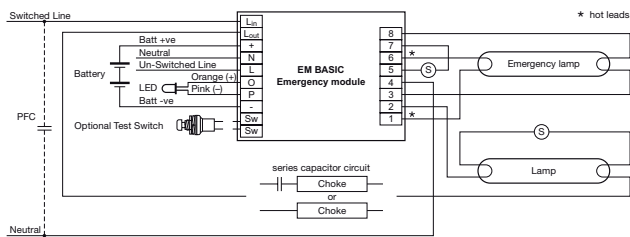

Twin series switch start circuit with conventional control gear

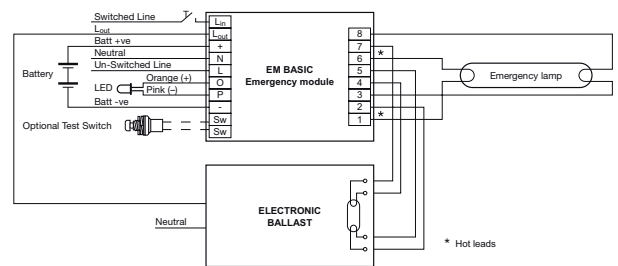

Single lamp high frequency electronic ballast

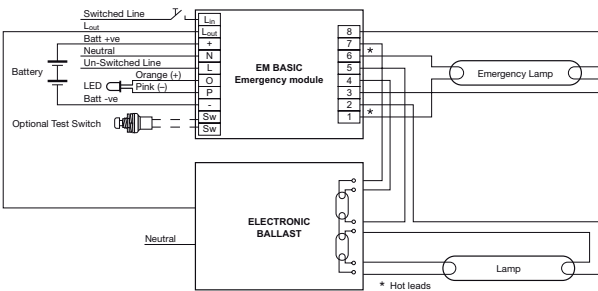

Twin series switch start circuit with high frequency electronic ballast

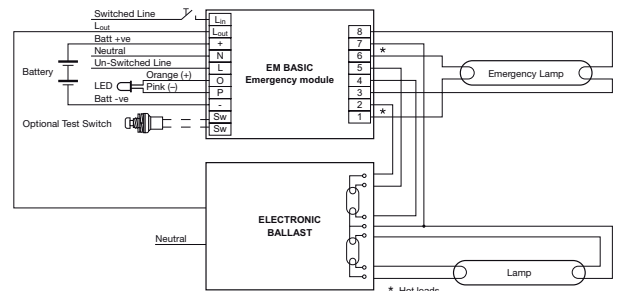

Twin lamp high frequency electronic ballast (7 lamp lead connections)

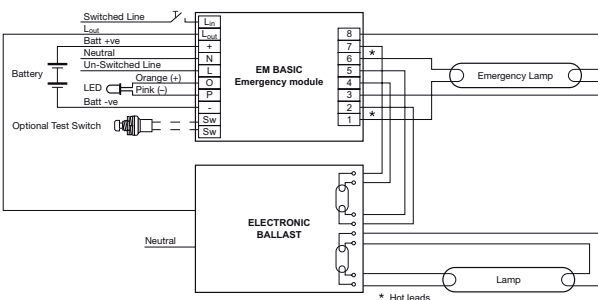

Twin lamp high frequency electronic ballast (8 lamp lead connections)

Additional information

Additional technical information at www.tridonic.com → Technical Data

Guarantee conditions at www.tridonic.com → Services

Life-time declarations are informative and represent no warranty claim. No warranty if device was opened.